

WEMARO®

SINCE 1989



Präzise . Schnell . Innovativ

WEMARO

Über uns WEMARO Tools GmbH

Weltmarktführer für Werkzeuge in der Fenster- und Türenindustrie

Wir sind ein dynamisches Unternehmen, das sich auf die Entwicklung, Herstellung und den Vertrieb von Werkzeugen zur Bearbeitung von Kunststoff-, Aluminium-, Stahl- und Verbundwerkstoff- Profilen in der Fenster-, Fassaden- und Türenindustrie spezialisiert hat.

Unser Hauptaugenmerk richten wir vor allem auf die Zusammenarbeit und Kommunikation mit unseren Kunden. Durch unsere Erfahrung können wir gezielt auf Probleme eingehen und Lösungsvorschläge erarbeiten.

Unsere modernsten Fertigungstechnologien ermöglichen es uns, flexibel und schnell auf die Wünsche unserer Kunden zu reagieren. Sonderanfertigungen und Kleinstserien gehören deshalb zu unseren großen Stärken.

WEMARO Werkzeuge unterliegen strengsten Qualitätsanforderungen und werden kontinuierlich überprüft und weiterentwickelt.

About us WEMARO Tools GmbH

The World Leading Supplier of tools for the manufactures of windows and doors

We are a dynamic organisation with a wide breadth of experience in the development, manufacture and sales of cutting tools for UPVC-, aluminium, steel and composite materials and profiles for the industries of windows, doors and curtain walls.

Our specialised knowledge is highly valued by our customers and is a corner stone of our business strategy. We work together with our customers to provide the best solution for their application. But no matter how small the problem, our specialists are delighted to serve our customers giving advice and speedy applications support.

Incorporating all the recent developments in technology our streamlined production methods enable us to react fast to our customer needs. On-off's and small batches are generally no problem.

WEMARO Tools are tested to the highest quality standards and are continually developed and improved.



WEMARÉ



Fräser aus HSS-E und Vollhartmetall

Produktgruppen 91000 bis 91155

Zur Bearbeitung von Kunststoff, Aluminium, Stahl und Verbundwerkstoff

Milling Cutters HSS-E and tungsten-carbide

product categories 91000 to 91155

for UPVC-, aluminium-, steel- and composite materials



Bohrer aus HSS-E und Vollhartmetall

Produktgruppen 91201 bis 91600

Zur Bearbeitung von Kunststoff, Aluminium, Stahl und Verbundwerkstoff

Drill bits HSS-E and tungsten-carbide

product categories 91201 to 91600

for UPVC-, aluminium-, steel- and composite materials



Sägeblätter HM-bestückt, HSS-E und DIA/PKD

Produktgruppen 92000 bis 92061

Zur Bearbeitung von Kunststoff, Aluminium, Stahl und Verbundwerkstoff

Sawblades HSS-E, carbide-tipped and PCD

product categories 92000 bis 92061

for UPVC-, aluminium-, steel- and composite materials



Zubehör und Ersatzteile

Produktgruppen 93000 bis 95630

Für die Türen- und Fensterindustrie

Accessories and spare parts

product categories 93000 bis 95630

for the industries of windows, doors and curtain walls

NEWARK

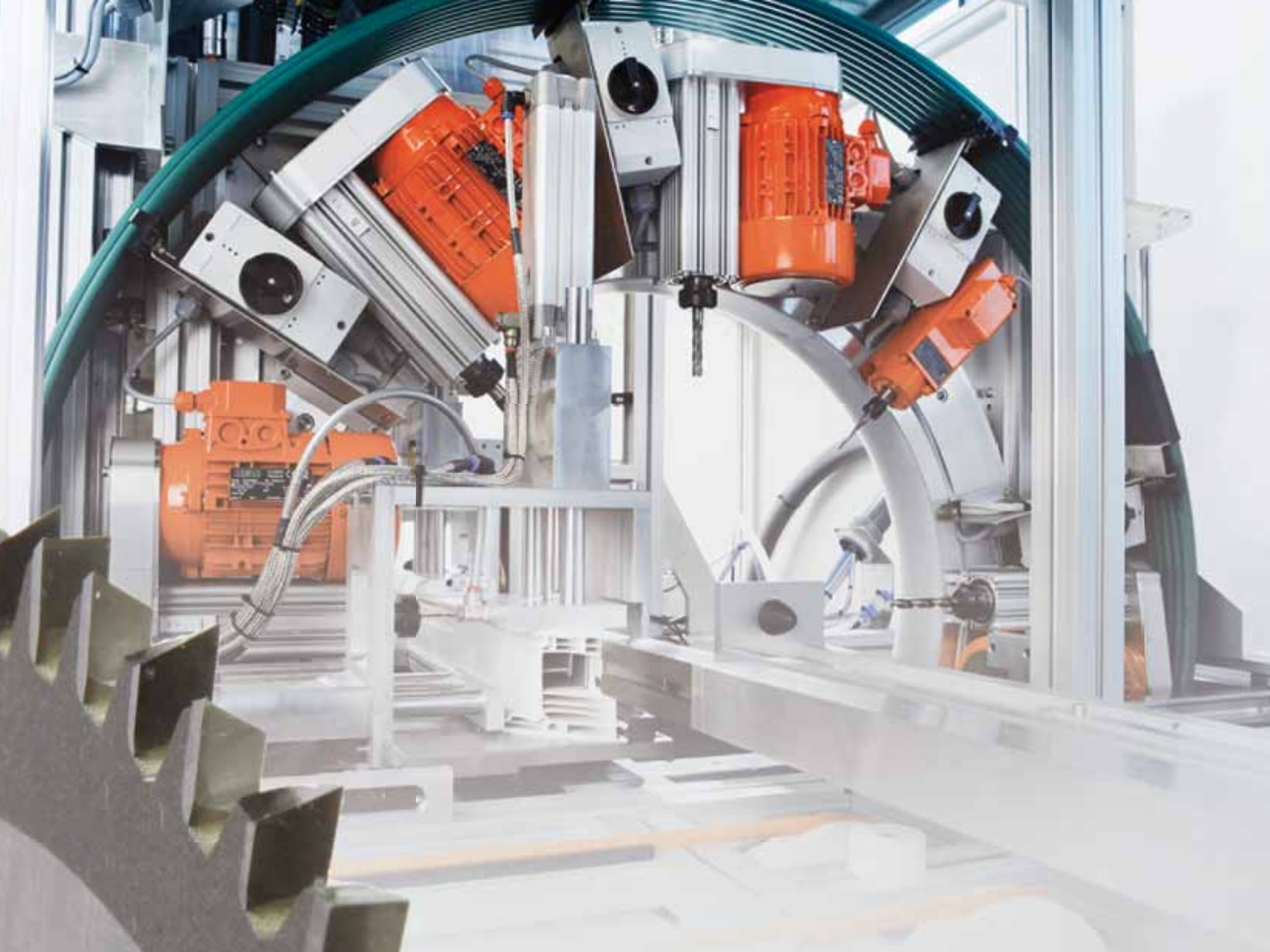

Partner seit 1990

**THORWESTEN**
MASCHINENBAU



WEMARO[®]

SINCE 1989

zum Fräsen und Bohren von Profilen aus Aluminium, Kunststoff und NE-Metallen

- verwendbar auf allen Kopierfräsen, Wasserschlitzfräsen und Bearbeitungszentren:
AFS, BJM, elumatec, Emmegi, FOM, Haffner, KABAN, Kombimatec, MLA, Pertici, Pressta-Eisele, Rapid, Rotox, Schirmer, Striffler, TEKNA, Thorwesten, Wegoma, etc.
- Drehzahlbereich ca. 8.000 - 20.000 UpM
- bei Aluminiumbearbeitung ist auf direkte und ausreichende Kühlung zu achten !

Single flute cutter HSS-E

for slotting and drilling in Aluminium- and UPVC-profiles

- used on copyrouters, drainage slot routers and CNC-machining-centres:
AFS, BJM, elumatec, Emmegi, FOM, Haffner, KABAN, Kombimatec, MLA, Pertici, Pressta-Eisele, Rapid, Rotox, Schirmer, Striffler, TEKNA, Thorwesten, Wegoma, etc.
- speed approx. 8.000 - 20.000 rpm
- direct and adequate cooling-spray is particularly important for aluminium working !

Art.-Nr.	A	B	D	E
060 008 003	3	12	60	8
060 006 004	4	12	60	6
060 008 004	4	12	60	8
060 008 204	4	20	60	8
080 008 004	4	12	80	8
080 008 254	4	25	80	8
010 008 254	4	25	100	8
010 008 124	4	12	100	8
011 008 004	4	40	100	8
011 008 204	4	20	120	8
060 006 005	5	12	60	6
060 008 005	5	12	60	8
060 008 185	5	18	60	8
070 008 255	5	25	70	8
080 008 255	5	25	80	8
080 008 355	5	35	80	8
090 008 255	5	25	90	8
090 008 355	5	35	90	8
010 008 145	5	14	100	8
011 008 025	5	20	100	8
011 008 255	5	25	100	8
011 008 305	5	30	100	8
011 008 005	5	40	100	8
011 008 545	5	45	100	8
020 008 005	5	14	120	8
011 008 205	5	40	120	8
060 006 006	6	14	60	6
060 008 006	6	14	60	8
070 008 256	6	25	70	8
080 008 006	6	14	80	8
080 008 256	6	25	80	8
010 008 146	6	14	100	8
011 008 006	6	40	100	8
060 008 007	7	14	60	8
080 008 007	7	14	80	8
080 008 008	8	14	80	8
080 008 258	8	25	80	8
080 008 408	8	40	80	8
010 008 008	8	14	100	8
010 008 258	8	25	100	8

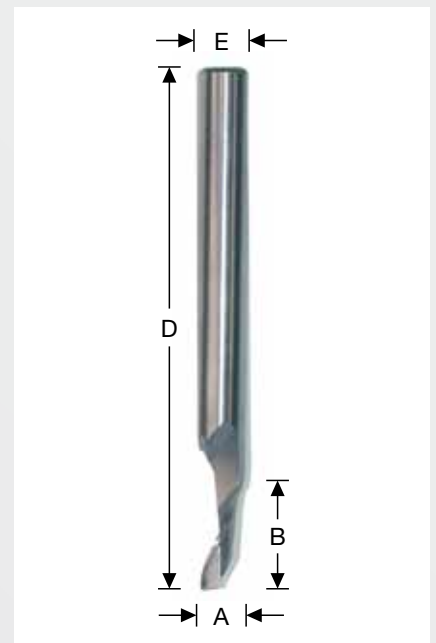

011 008 008	8	40	100	8
020 008 008	8	14	120	8
020 008 258	8	25	120	8
020 008 408	8	40	120	8
080 008 009	9	14	80	8
011 008 009	9	40	100	8
080 008 010	10	14	80	8
010 008 140	10	14	100	8
010 008 010	10	22	100	8
080 010 010	10	14	80	10
020 010 010	10	14	120	10
080 008 011	11	14	80	8
080 008 012	12	14	80	8
090 008 512	12	50	90	8
010 008 012	12	28	100	8
080 010 012	12	14	80	10



zum Fräsen und Bohren von Profilen aus Aluminium, Kunststoff und NE-Metallen

- verwendbar auf allen Kopierfräsen, Wasserschlitzfräsen und Bearbeitungszentren:
AFS, BJM, elumatec, Emmegi, FOM, Haffner, KABAN, Kombimatec, MLA, Pertici, Pressta-Eisele, Rapid, Rotox, Schirmer, Striffler, TEKNA, Thorwesten, Wegoma, etc.
- Drehzahlbereich ca. 8.000 - 20.000 UpM
- bei Aluminiumbearbeitung ist auf direkte und ausreichende Kühlung zu achten !

Single flute cutter HSS-E - stepped shank -

for slotting and drilling in Aluminium- and UPVC-profiles

- used on copyrouters, drainage slot routers and CNC-machining-centres:
AFS, BJM, elumatec, Emmegi, FOM, Haffner, KABAN, Kombimatec, MLA, Pertici, Pressta-Eisele, Rapid, Rotox, Schirmer, Striffler, TEKNA, Thorwesten, Wegoma, etc.
- speed approx. 8.000 - 20.000 rpm
- direct and adequate cooling-spray is particularly important for aluminium working !

Art.-Nr.	A	B	C	D	E
080 108 004	4	18	35	80	8
090 108 004	4	16	45	90	8
080 106 005	5	18	35	80	6
080 108 005	5	18	35	80	8
090 108 005	5	16	45	90	8
090 108 155	5	16	55	90	8
010 108 005	5	18	35	100	8
010 108 255	5	25	55	100	8
020 108 005	5	14	35	120	8
020 108 175	5	14	75	120	8
020 108 145	5	20	45	120	8
025 108 005	5	14	65	125	8
080 108 006	6	14	35	80	8
090 108 006	6	16	45	90	8
010 108 006	6	18	35	100	8
080 108 007	7	14	45	80	8
080 108 008	8	14	54	80	8
010 108 008	8	14	68	100	8
010 108 308	8	30	70	100	8
020 108 008	8	14	90	120	8
020 108 308	8	30	70	120	8
085 110 010	10	14	65	85	10
090 010 451	10	25	45	90	10
096 110 010	10	14	75	96	10
010 110 010	10	30	70	100	10
020 110 010	10	14	95	120	10
020 110 310	10	30	70	120	10

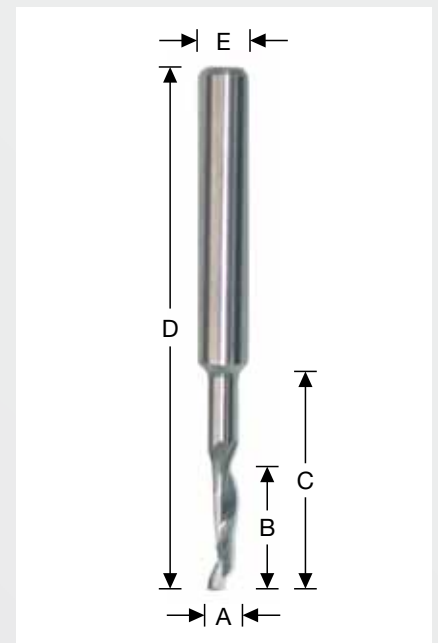

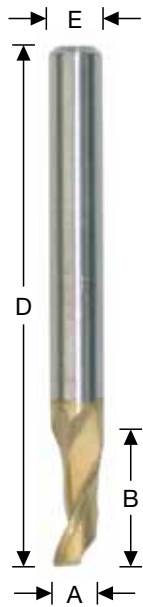

- **TIN-beschichtet**
für längere Standzeit bei PVC-Bearbeitung

Single flute cutter HSS-E

- **TIN-coated**
for longer durability in UPVC-Profiles

Art.-Nr.	A	B	C	D	E
060 018 004	4	12		60	8
060 018 005	5	12		60	8
060 018 185	5	18		60	8
080 118 005	5	18	35	80	8
090 118 005	5	16	45	90	8
011 018 255	5	25		100	8
011 018 005	5	40		100	8
060 018 006	6	14		60	8
080 018 008	8	14		80	8
080 118 008	8	14	54	80	8
020 018 008	8	14		120	8



Perfekte Wasserschlitzte – für alle Anwendungsfälle den optimalen Fräser...

Perfect waterslots – for all scope the suitable drainage cutter

- CrN-beschichtet
für längere Standzeit bei Aluminium-Bearbeitung

Single flute cutter HSS-E

- CrN-coated
for longer durability in Aluminium-profiles

Art.-Nr.	A	B	C	D	E
060 028 003	3	12		60	8
060 028 004	4	12		60	8
060 028 005	5	12		60	8
060 028 185	5	18		60	8
080 128 005	5	18	35	80	8
080 028 355	5	35		80	8
060 028 006	6	14		60	8
080 128 006	6	18	35	80	8
060 028 007	7	14		60	8
080 028 008	8	14		80	8
080 128 008	8	14	54	80	8
080 028 258	8	25		80	8
090 028 451	10	25	45	90	10

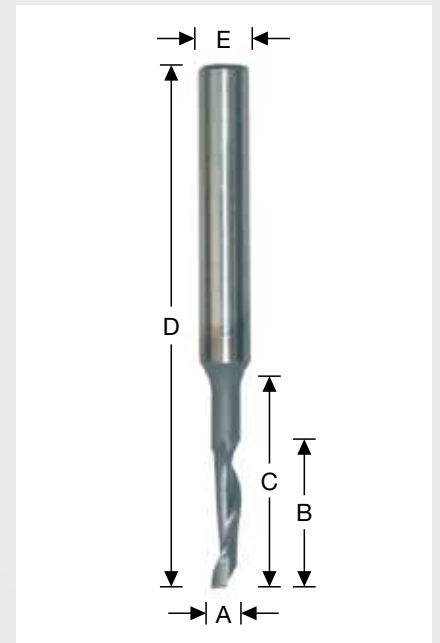

Vollautomatische CNC-Schleifzentren mit CBN-Schleiftechnologie ermöglichen höchste Präzision und Wiederholgenauigkeit

Fully automatic CNC grinding centres with CBN grinding technology guarantee highest precision and repetition



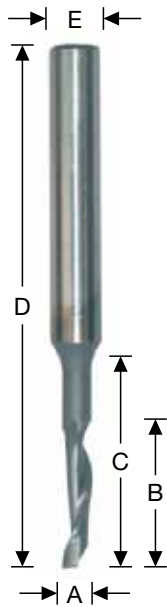

Einzahnfräser HSS-E

91005

- **TiCN-beschichtet**
für längere Standzeit bei Aluminium- und PVC-Bearbeitung

Single flute cutter HSS-E

- **TiCN-coated**
for longer durability in Aluminium- and UPVC-profiles

Art.-Nr.	A	B	C	D	E
060 048 005	5	12		60	8
060 048 006	6	14		60	8
060 048 007	7	14		60	8
080 048 008	8	14		80	8
080 148 005	5	18	35	80	8
080 148 008	8	14	54	80	8

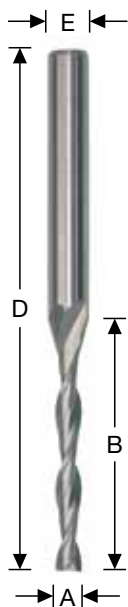

Wasserschlitzfräser HSS-E

91010

für Wasserschlitzfräsen
elumatec, Haffner, Kombimatec, MLA, ROTOX, Striffler, Wegoma, etc.

Zweischneidig, spiralig
Für Aluminium-Bearbeitung

Waterslot cutter HSS-E

for elumatec, Haffner, Kombimatec, MLA, ROTOX, Striffler, Wegoma, etc.

Two flutes, spiral
For aluminium-working

Art.-Nr.	A	B	D	E
012 008 905	5	30	90	8
012 008 005	5	40	100	8

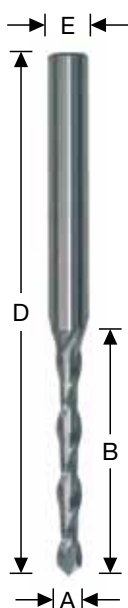

Wasserschlitzfräser HSS-E

91011

für Wasserschlitzfräsen
elumatec, Haffner, Kombimatec, MLA, ROTOX, Striffler, Wegoma, etc.

Zweischneidig, spiralig mit Bohrerspitze
Für PVC-Bearbeitung

Waterslot cutter HSS-E

for elumatec, Haffner, Kombimatec, MLA, ROTOX, Striffler, Wegoma, etc.

Two flutes, spiral with drill point
For UPVC-working

Art.-Nr.	A	B	D	E
014 006 005	5	45	100	6
014 008 305	5	30	90	8
014 008 495	5	40	90	8
014 008 405	5	40	100	8

Bohrnutenfräser HSS-E

91012

für elumatec, Haffner, Kombimatec, MLA, ROTOX, Pertici, etc.

Zweischneidig, spiralig, leichter Drall, Rechtslauf / Linksdrall

für Aluminium- und PVC-Profilbearbeitung.

Spezialausführung für höchste Beanspruchung.

Milling cutter HSS-E

for elumatec, Haffner, Kombimatec, MLA, ROTOX, Pertici, etc.

Two flutes, spiral, slow spiral, RH cut / LH spiral

for aluminium- and UPVC-routing and waterslotting.

Specially designed to give added strength and prevent breakages.

Art.-Nr.	A	B	D	E
015 008 440	4	40	100	8
015 008 535	5	35	80	8
015 008 540	5	40	100	8
015 008 545	5	45	120	8

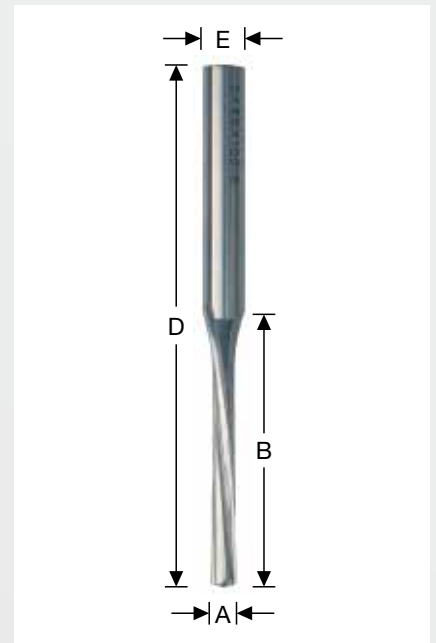

Wasserschlitzzfräser HSS-E

91021

für Wasserschlitzzräsen

elumatec, Haffner, Kombimatec, MLA, ROTOX, Striffler, Wegoma, etc.

Einschneidig, gerade, mit Bohrerspitze

Für PVC-Bearbeitung

Waterslot cutter HSS-E

for elumatec, Haffner, Kombimatec, MLA, ROTOX, Striffler, Wegoma, etc.

Single flute, straight, with drill point

For UPVC-working

Art.-Nr.	A	B	C	D	E
013 008 254	4	25		100	8
013 008 705	5	30		70	8
013 008 305	5	35		80	8
013 008 485	5	45		90	8
013 008 355	5	35		100	8
013 008 455	5	45		100	8
013 008 555	5	55		100	8
013 120 545	5	45		120	8
013 008 306	6	30		100	8
013 008 456	6	45		100	8
013 108 308	8	30	62	100	8

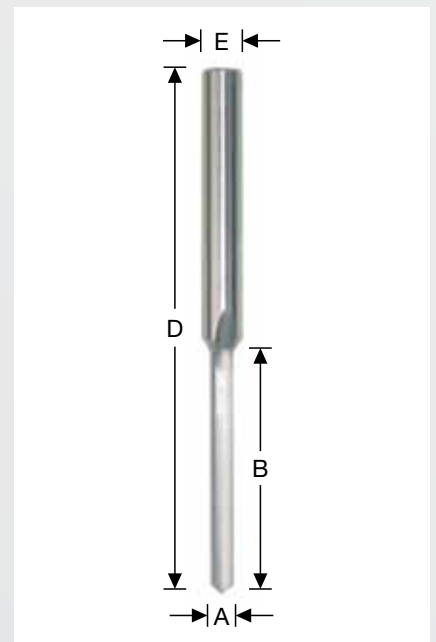

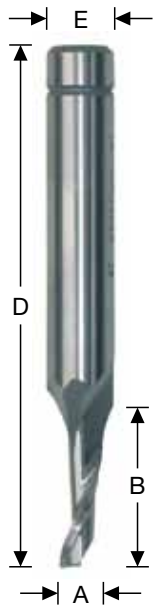

Einzahnfräser HSS-E

91022

Spezialausführung für Stahlprofile

- verwendbar auf allen Kopierfräsen und Bearbeitungszentren: elumatec, Emmegi, Haffner, MLA, Pertici, Pressta-Eisele, Rapid, Rotox, Striffler, TEKNA, Wegoma, etc.
- Drehzahlbereich ca. 6.000 - 12.000 UpM
- auf direkte und ausreichende Kühlung ist zu achten !

Single flute cutter HSS-E

Special cutters for steel cutting

- used on copyrouters and CNC-machining-centres: elumatec, Emmegi, Haffner, MLA, Pertici, Pressta-Eisele, Rapid, Rotox, Striffler, TEKNA, Wegoma, etc.
- speed approx. 6.000 - 12.000 rpm
- direct and adequate cooling-spray is particularly important for steel working !

Art.-Nr.	A	B	D	E
160 008 005	5	12	60	8
180 008 008	8	14	80	8

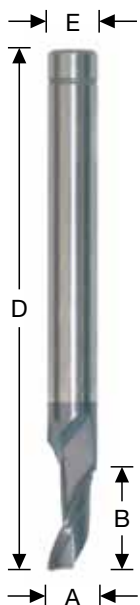

Einzahnfräser HSS-E

91023

Spezialausführung für Stahlprofile

- beschichtet für längere Standzeit

- verwendbar auf allen Kopierfräsen und Bearbeitungszentren: elumatec, Emmegi, Haffner, MLA, Pertici, Pressta-Eisele, Rapid, Rotox, Striffler, TEKNA, Wegoma, etc.
- Drehzahlbereich ca. 6.000 - 12.000 UpM
- auf direkte und ausreichende Kühlung ist zu achten !

Single flute cutter HSS-E

Special cutters for steel cutting

- coated for longer durability

- used on copyrouters and CNC-machining-centres: elumatec, Emmegi, Haffner, MLA, Pertici, Pressta-Eisele, Rapid, Rotox, Striffler, TEKNA, Wegoma, etc.
- speed approx. 6.000 - 12.000 rpm
- direct and adequate cooling-spray is particularly important for steel working !

Art.-Nr.	A	B	D	E
160 038 005	5	12	60	8
180 038 008	8	14	80	8

Einschneidig, spiralg

Spezialausführung für Stahlprofile

- verwendbar auf allen Kopierfräsen und Bearbeitungszentren:
elumatec, Emmegi, Haffner, MLA, Pertici, Pressta-Eisele, Rapid, Rotox, Striffler, TEKNA, Wegoma, etc.
 - Drehzahlbereich ca. 6.000 - 12.000 UpM
 - bei Stahlbearbeitung ist auf direkte und ausreichende Kühlung zu achten !
- Zur Bearbeitung von Stahlprofilen auf Kopierfräsen

Double-ended single flute cutter -solid carbide-

Single flute, spiral

Special cutters for steel cutting

- used on copyrouters and CNC-machining-centres:
elumatec, Emmegi, Haffner, MLA, Pertici, Pressta-Eisele, Rapid, Rotox, Striffler, TEKNA, Wegoma, etc.
 - speed approx. 6.000 - 12.000 rpm
 - direct and adequate cooling-spray is particularly important for steel working !
- For working steel profiles on copy-routers

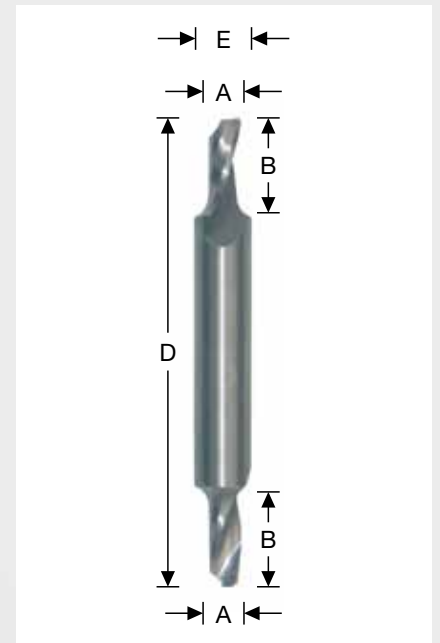

Art.-Nr.	A	B	D	E
065 708 005	5	11	65	8



Fräser-Produktion auf modernem Maschinenpark mit CNC-Technik

Production on modern machine plants combined with up-to-date CNC technique

mit Spezial-Stirnanschliff für leichtes Eintauchen

Zweischneidig, spiralig
Für Aluminium und Kunststoff

Milling cutter HSS-E

special grinded for easy drilling

Two flutes, spiral
For aluminium and UPVC

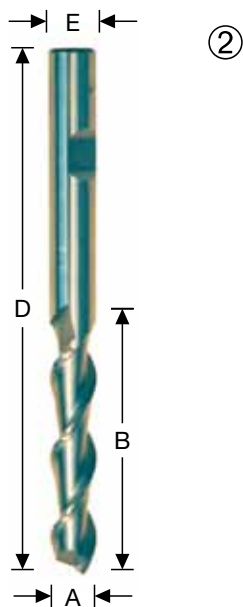
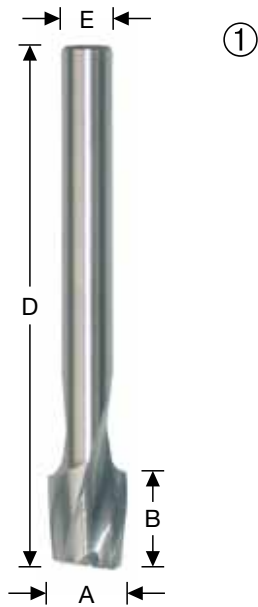

Art.-Nr.	A	B	C	D	E	Bild
082 008 004	4	12		60	8	1
082 008 005	5	12		60	8	1
082 008 006	6	14		60	8	1
082 008 007	7	14		60	8	1
082 008 008	8	14		80	8	1
082 008 208	8	30		100	8	2
082 008 308	8	40		100	8	2
082 108 258	8	25	80	120	8	2
082 010 008	8	38		88	10	2
082 008 010	10	14		80	8	1
082 010 010	10	45		95	10	2
012 010 010	10	25		120	10	2
082 008 012	12	14		80	8	1
012 012 012	12	30		120	12	2
082 012 112	12	53		110	12	2
082 012 013	13	26		83	12	1
082 012 114	14	53		110	12	2
082 016 016	16	63		123	16	2
082 016 018	18	63		123	16	2
082 020 020	20	75		141	20	2

Bohrnutenfräser HSS-E

91026

Zweischneidig, gerade genutet

Für PVC-Bearbeitung auf Kopierfräsen (z.B. Schlosskästen)

Slot milling cutter HSS-E

Two flutes, straight

For UPVC-working, used on copyrouters

Art.-Nr.	A	B	D	E		
080 008 275	5	27	80	8		
010 008 305	5	35	100	8		
010 008 306	6	30	100	8		
010 008 307	7	30	100	8		
090 008 158	8	15	90	8		
010 008 308	8	30	100	8		
075 010 008	8	30	75	10		
075 008 010	10	40	75	8		
097 010 010	10	40	97	10		
097 010 110	10	50	100	10		
075 008 012	12	40	75	8		
075 010 012	12	40	75	10		
097 010 012	12	48	97	10		
097 010 014	14	48	97	10		
097 010 016	16	48	97	10		
097 010 018	18	48	97	10		
097 710 010	10	40	97	10	HM-best.	Carb. tip.
097 710 012	12	40	97	10	HM-best.	Carb. tip.
097 710 014	14	40	97	10	HM-best.	Carb. tip.
090 778 016	16	30	90	8	HM-best.	Carb. tip.
097 710 016	16	45	97	10	HM-best.	Carb. tip.

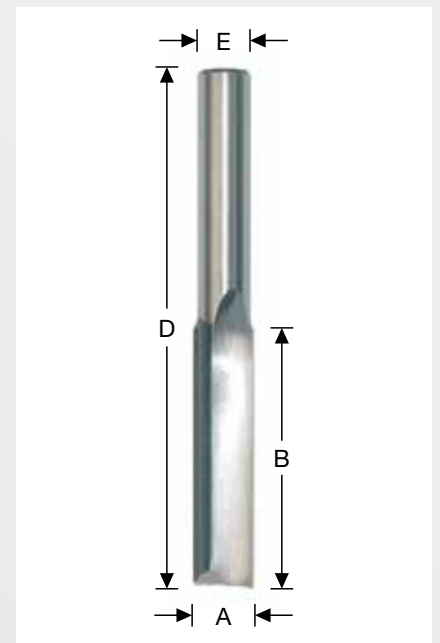

Schlosskastenfräser HSS-E

91027

Zweischneidig, spiralig

Für PVC-Bearbeitung

Slot milling cutter HSS-E

Two flutes, spiral

For UPVC-working

Art.-Nr.	A	B	D	E		
082 008 312	12	25	75	8		
082 008 412	12	25	85	8		
082 008 512	12	50	90	8		
082 008 314	14	25	75	8		

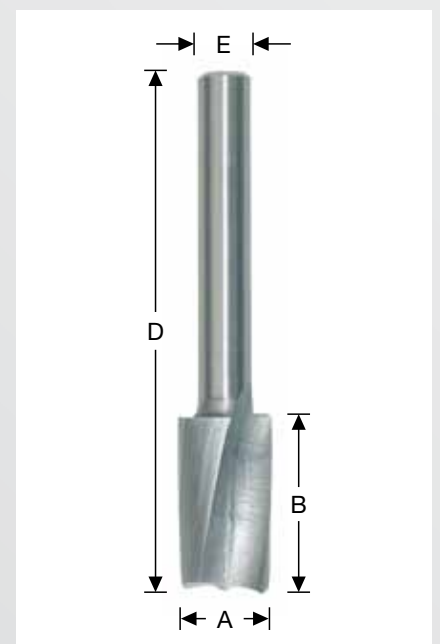

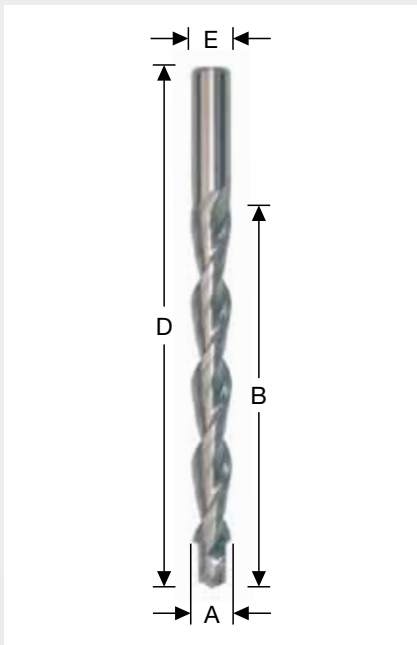

Fräsbohrer HSS-E - elumatec -

91029

passend zu elumatec KF 78/60

Routing drill HSS-E - elumatec -

for elumatec KF 78/60

Art.-Nr.	A	B	D	E
078 365 100	10	90	148	10
078 365 101	10	72	126	10

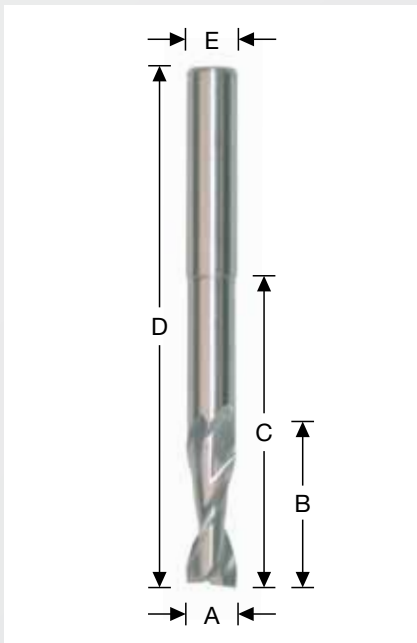

Schafffräser HSS-E - elumatec -

91030

passend zu elumatec KF 178

Zweischneidig, spiralig

R = Rechtslauf - L = Linkslauf

Milling cutter HSS-E - elumatec -

for elumatec KF 178

Two flutes, spiral

R = RH-rotation - L = LH-rotation

Art.-Nr.	A	B	C	D	E	
178 366 010	10	22	60	100	10	R
178 366 110	10	22	40	100	10	L
178 366 210	10	22	70	120	10	R

Stufenfräser HSS-E

91031

für **ROTOX-Kopierfräsen**

R = Rechtslauf - L = Linkslauf

Stepped cutter HSS-E

for **ROTOX-copy routers**

R = RH-rotation - L = LH-rotation

Art.-Nr.	a	A	D	E	
015 361 017	10,5	17,5	75	10	R
015 361 117	10,5	17,5	75	10	L
015 361 617	10,5	17,5	95	10	R
015 361 717	10,5	17,5	95	10	L

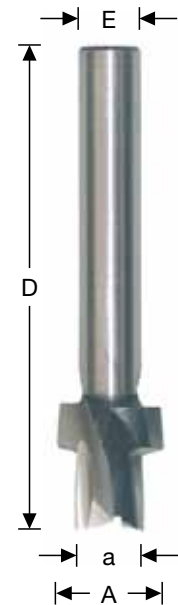

Innenfalz- / Dichtungsnutfräser HSS-E

91032

für **Schweißraupen-Verputzmaschinen**

z.B. elumatec, Stürtz, Urban, Rotox, Wegoma, etc.

Vollhartmetall auf Anfrage.

TIN-Beschichtung auf Anfrage

Router cutter & gasket groove cutter HSS-E

for **corner cleaning machines**

as elumatec, Stürtz, Urban, Rotox, Wegoma, etc.

Solid-carbide on demand.

TIN-coating on demand

Art.-Nr.	A	B	D	E	Z/T	
068 006 005	5	24	68	6	2	
068 006 006	6	24	68	6	2	
016 706 006	6	20	120	6	2	VHM / TC
016 178 006	6	25	100	8	2	VHM / TC
016 128 206	6	20	120	8	2	
016 128 306	6	20	120	8	3	
055 006 065	6,5	16	55	6	2	
066 006 065	6,5	16	66	6	2	
075 006 065	6,5	16	75	6	2	
016 108 207	7	20	100	8	2	
016 108 307	7	20	100	8	3	
016 178 007	7	25	100	8	2	VHM / TC
016 128 207	7	20	120	8	2	
016 128 307	7	20	120	8	3	
055 006 075	7,5	16	55	6	2	
066 006 075	7,5	16	66	6	2	
075 006 075	7,5	16	75	6	2	
016 108 308	8	20	100	8	3	
016 128 208	8	20	120	8	2	
016 128 308	8	20	120	8	3	

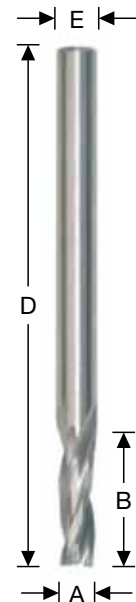

Dichtnutfräser?

Kein Problem!

Wir haben über 40 verschiedene Größen und Ausführungen...

Routers/drills for gasket grooves? No problem – we keep in stock more than 40 several sizes and types...

für Bearbeitungszentren elumatec, Stürtz, Thorwesten, Wegoma, etc.

Slot milling cutter HSS-E

for CNC-machines as elumatec, Stürtz, Thorwesten, Wegoma, etc.

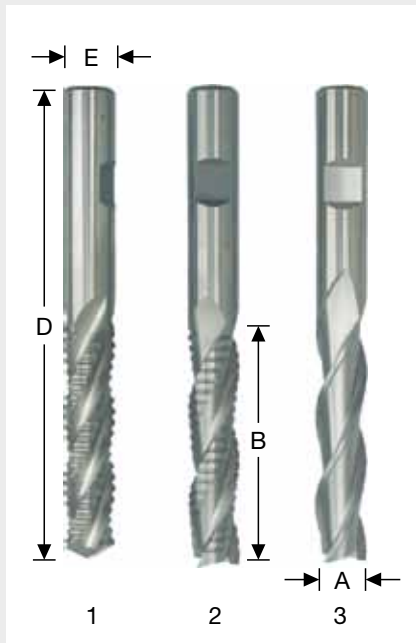

Art.-Nr.	A	B	D	E	Z/T	P
084 010 010	10	45	95	10	4	2
084 010 910	10	45	95	10	4	1
084 012 012	12	53	110	12	4	2
084 012 212	12	53	110	12	3	2
084 012 112	12	53	110	12	4	3
084 012 312	12	53	110	12	3	3
084 012 912	12	53	110	12	4	1
084 012 013	13	53	110	12	4	2
084 012 214	14	53	110	12	3	2
084 012 914	14	53	110	12	4	1
084 012 412	12	85	130	12	4	2
084 012 414	14	85	130	12	4	2

**Bohrnutenfräser (Schrupp + Schlicht) für rationelle Bearbeitung
z. B. für Schlosskästen oder industrielle Profile usw.**

***Slot milling cutters (also roughing type) for economical working
on lockboxes or industrial profiles etc.***

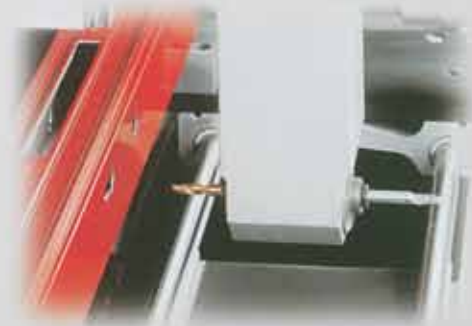

zur Bearbeitung von PVC-Profilen mit Handmaschinen.
z.B. Rotox, Striffler, STRIMA, etc.

Milling cutter HSS, female thread M10

for working UPVC-profiles with hand-routers
as Rotox, Striffler, STRIMA, etc.

Art.-Nr.	A	B	C	
052 100 003	3	8	52	
035 100 004	4	10	35	
052 100 004	4	12	52	
035 100 005	5	10	35	
052 100 005	5	23	52	
052 100 006	6	23	52	
047 100 008	8	26	47	
043 100 010	10	20	43	
050 100 115	11,5	17	50	
043 100 012	12	14,5	43	
043 100 112	12	23	43	
058 100 012	12	38	58	
080 100 012	12	45	80	M12x1
043 100 014	14	21	43	
043 100 016	16	23	43	
043 100 018	18	23	43	
043 700 012	12	14,5	43	HM Carb.-tip.

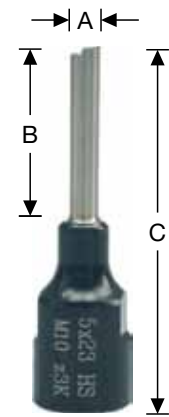

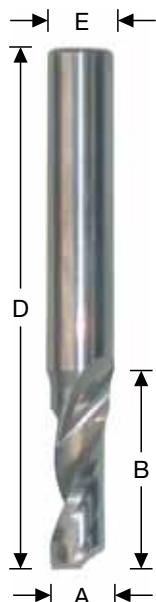

zum Fräsen und Bohren von Profilen aus Aluminium, Kunststoff und NE-Metallen

- verwendbar auf allen Bearbeitungszentren:
BJM, elumatec, Emmegi, FOM, Haffner, Handtmann, HEFI, Italmac, Mecal, MLA, Pertici, Pressta-Eisele, Rapid, Rotox, Schirmer, Schüco, Striffler, TEKNA, Wegoma, etc.
 - Drehzahlbereich ca. 8.000 - 30.000 UpM
 - bei Aluminiumbearbeitung ist auf direkte und ausreichende Kühlung zu achten!
- Zur Bearbeitung von Aluminium- und Kunststoffprofilen

Single flute cutter -solid carbide-

for slotting and drilling in Aluminium- and UPVC-profiles.

- used on CNC-machining-centres:
BJM, elumatec, Emmegi, FOM, Haffner, Handtmann, HEFI, Italmac, Mecal, MLA, Pertici, Pressta-Eisele, Rapid, Rotox, Schirmer, Schüco, Striffler, TEKNA, Wegoma, etc.
 - speed approx. 8.000 - 30.000 rpm
 - direct and adequate cooling-spray is particularly important for aluminium working!
- For working of aluminium- and UPVC profiles

Art.-Nr.	A	B	D	E
050 706 002	2	10	50	6
050 703 03	3	12	50	3
050 706 003	3	12	50	6
060 708 003	3	12	60	8
070 706 032	3,2	12	70	6
050 704 004	4	15	50	4
070 704 040	4	12	70	4
060 705 004	4	25	60	5
060 706 004	4	14	60	6
070 706 004	4	8	70	6
070 706 040	4	12	70	6
060 708 004	4	20	60	8
060 705 005	5	20	60	5
070 705 050	5	12	70	5
070 705 005	5	30	70	5
080 705 005	5	40	80	5
080 705 045	5	45	80	5
090 705 005	5	30	90	5
060 706 005	5	20	60	6
080 706 005	5	40	80	6
060 708 005	5	20	60	8
070 708 005	5	15	70	8
070 708 305	5	30	70	8
080 708 005	5	20	80	8
080 708 305	5	30	80	8
080 708 045	5	40	80	8
090 708 205	5	20	90	8
090 708 005	5	30	90	8
010 708 005	5	12	100	8
010 708 025	5	20	100	8
011 708 005	5	40	100	8
020 708 005	5	20	120	8
060 706 006	6	16	60	6
060 706 026	6	20	60	6
070 706 060	6	12	70	6
075 706 006	6	20	75	6
080 706 036	6	30	80	6

Schüco

080 706 006	6	40	80	6
010 706 006	6	12	100	6
010 706 306	6	30	110	6
060 708 006	6	16	60	8
060 708 007	7	18	60	8
060 708 008	8	18	60	8
070 708 080	8	12	70	8
070 708 008	8	25	75	8
080 708 358	8	35	80	8
090 708 008	8	35	90	8
010 708 080	8	16	100	8
010 708 308	8	30	100	8
020 708 008	8	14	120	8
020 708 358	8	35	120	8
150 708 008	8	50	150	8
090 708 510	10	50	90	8
070 710 110	10	22	70	10
070 710 010	10	28	75	10
080 710 310	10	30	80	10
083 710 010	10	45	83	10
090 710 010	10	20	90	10
010 710 710	10	30	100	10
097 710 110	10	40	100	10
010 710 521	10	52	100	10
083 710 012	12	35	83	10
083 710 412	12	45	83	10
070 712 012	12	24	70	12
080 712 012	12	32	80	12
080 712 412	12	42	80	12
090 712 012	12	55	90	12
010 712 712	12	35	100	12
020 712 012	12	40	120	12
083 710 413	13	45	83	10
083 710 014	14	35	83	10
075 714 140	14	26	75	14
090 716 016	16	25	90	16
010 720 020	20	30	100	20

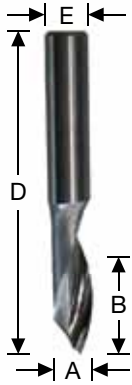

Spezialausführung zur Hochgeschwindigkeitsbearbeitung von Aluminium auf Bearbeitungszentren

- z.B. elumatec, Emmegi, FOM, Handtmann, Rapid, etc.
- höhere Drehzahlen und Vorschübe möglich = Kostenreduzierung
- Geräuschreduzierung
- bis zu 3-fach höhere Standzeit

Single flute cutter -solid carbide- polished

Special version for high-speed cutting/HSC of aluminium extrusions on CNC-machining centres

- as elumatec, Emmegi, FOM, Handtmann, Rapid, etc.
- more speed and feed
- reduction in noise level
- extremely long life

Art.-Nr.	A	B	C	D	E
140 390 102	2	7		70	8
140 390 103	3	10		70	8
060 905 004	4	20		60	5
060 908 004	4	12		60	8
140 390 104	4	10		70	8
060 905 005	5	20		60	5
060 908 005	5	20		60	8
140 390 105	5	16		70	8
060 908 006	6	20		60	8
070 906 006	6	16		70	8
140 390 108	8	22		70	8
080 908 008	8	25		80	8
140 390 110	10	22		70	10
075 910 010	10	30		75	10
084 912 012	12	30		84	12
080 918 004	4	10	40	80	8
080 918 005	5	10	40	80	8
140 391 105	5	20	25	80	8
080 918 006	6	10	40	80	8
140 392 106	6	22	40	80	8
080 918 008	8	12	54	80	8
140 391 108	8	22	40	80	8
011 918 010	10	12	80	110	10

Spezialausführung mit zusätzlicher Spanleitstufe für optimalen Spanauswurf bei Aluminium-Bearbeitung auf Bearbeitungszentren
 - höchstmöglicher Vorschub bis 6.000 mm bei optimalem Fräsbild

Single flute cutter -solid carbide- -chipbreaker-

Special version with chipbreaker for aluminium extrusions on CNC-machining centres

- best possible feed up to 6.000 mm and best cutting result

Art.-Nr.	A	B	C	D	E	Bild
070 608 005	5	10		70	8	1
070 608 006	6	10		70	8	1
080 608 008	8	14		80	8	1
080 610 010	10	20		80	10	1
010 610 010	10	20	73	100	10	2
020 610 010	10	20	93	120	10	2

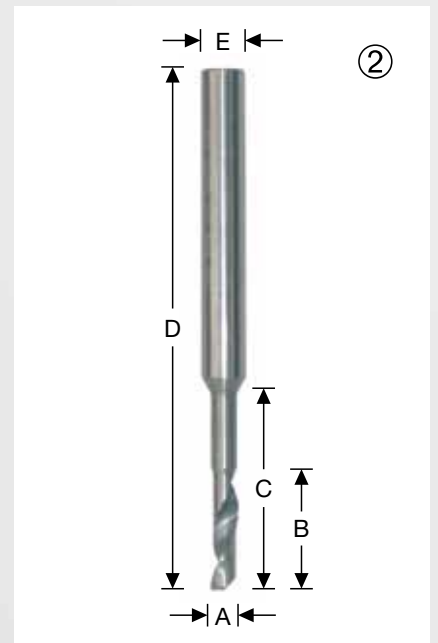
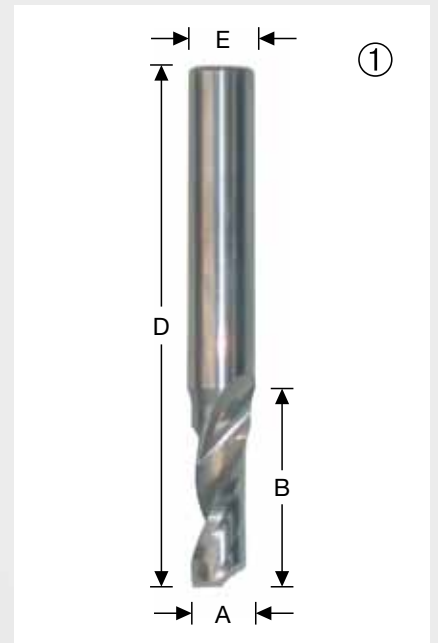

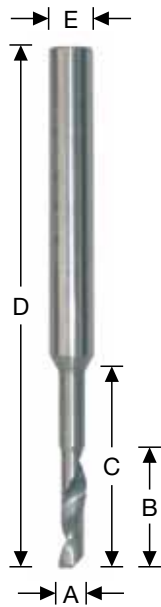

zum Fräsen und Bohren von Profilen aus Aluminium, Kunststoff und NE-Metallen

- verwendbar auf allen Bearbeitungszentren:

BJM, elumatec, Emmegi, FOM, Haffner, Handtmann, HEFI, Italmac, Mecal, MLA, Pertici, Pressta-Eisele, Rapid, Rotox, Schirmer, Schüco, Striffler, TEKNA, Wegoma, etc.

- Drehzahlbereich ca. 8.000 - 30.000 UpM

- bei Aluminiumbearbeitung ist auf direkte und ausreichende Kühlung zu achten !

Zur Bearbeitung von Aluminium- und Kunststoffprofilen

Single flute cutter -solid carbide-

Stepped shank -

for slotting and drilling in Aluminium- and UPVC-profiles.

- used on CNC-machining-centres:

BJM, elumatec, Emmegi, FOM, Haffner, Handtmann, HEFI, Italmac, Mecal, MLA, Pertici, Pressta-Eisele, Rapid, Rotox, Schirmer, Schüco, Striffler, TEKNA, Wegoma, etc.

- speed approx. 8.000 - 30.000 rpm

- direct and adequate cooling-spray is particularly important for aluminium working !

For working of aluminium- and UPVC profiles

Art.-Nr.	A	B	C	D	E	
070 714 032	3,2	12	40	70	4	
080 718 004	4	15	35	80	8	
077 716 005	5	8	40	77	6	Schüco
080 718 005	5	16	35	80	8	
090 718 005	5	20	45	90	8	
090 718 355	5	35	55	90	8	
010 718 305	5	30	50	100	8	
010 718 405	5	40	50	100	8	
010 718 355	5	30	60	100	8	
011 718 305	5	30	62	110	8	
025 718 005	5	15	45	125	8	
077 716 006	6	10	40	77	6	Schüco
080 718 006	6	20	35	80	8	
090 718 006	6	20	30	90	8	
070 718 007	7	18	45	70	8	
070 718 008	8	16	40	70	8	
080 718 008	8	10	40	80	8	Schüco
090 718 358	8	35	50	90	8	
010 718 008	8	16	70	100	8	
010 718 258	8	25	60	100	8	
020 718 008	8	35	80	120	8	
138 712 010	10	12	105	138	12	Schüco
011 710 010	10	15	65	110	10	Schüco
011 710 126	10	15	82	126	10	Schüco
010 711 010	10	20	70	100	10	
010 712 012	12	20	70	100	12	
010 716 016	16	30	50	100	16	

Einzahnfräser VHM

91106

- Spezialausführung - Linksdrall - Spanauswurf nach unten

Single flute cutter -solid carbide-

- Special version - RH/cut - LH/spiral - downward chip clearance

Art.-Nr.	A	B	D	E
038 703 203	3	10	38	3
040 704 204	4	14	60	4
060 705 205	5	20	60	5
060 705 255	5	25	60	5
080 705 205	5	40	80	5
080 705 250	5	50	80	5
010 705 205	5	70	100	5
060 706 206	6	20	60	6
075 708 208	8	20	75	8
090 708 208	8	40	90	8
075 710 210	10	30	75	10
075 712 212	12	30	75	12

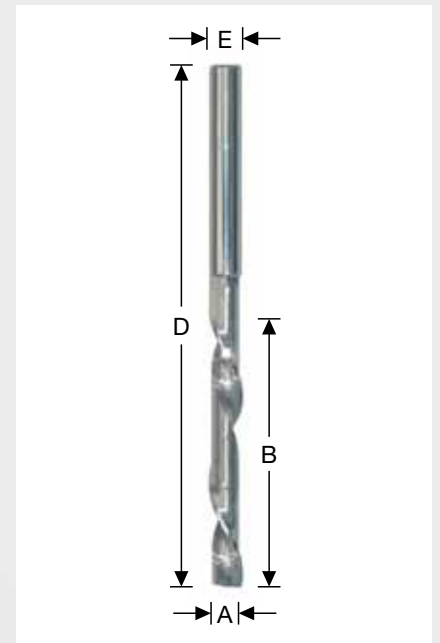

Wasserschlitzfräser VHM

91120

Einschneidig, Bohrspitze, flacher Drallwinkel

- Spezialausführung für CNC-Maschinen - z.B. SUPERCUT, etc.

Waterslot cutter -solid carbide-

Single-flute, drill point, flat twist angle

- special version for CNC-machines - as SUPERCUT, etc.

Art.-Nr.	A	B	D	E
060 705 305	5	25	60	5
080 705 305	5	40	80	5
080 706 306	6	40	80	6

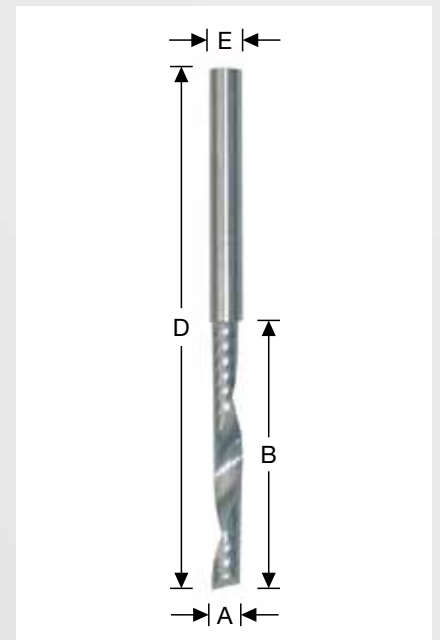

Fräser aus Vollhartmetall – optimierte Schneidengeometrie für Profilarbeitung ergibt beste Standzeiten!

Router cutters made of solid carbide – advanced cutting angles especially for profile working



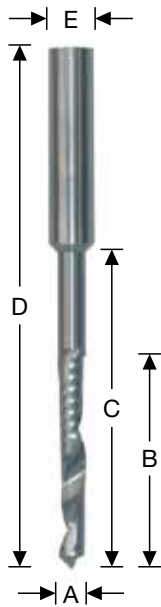

Einschneidig, spirilig

- Spezialausführung - für CNC-Maschinen - mit Bohrspitze 90°
- für Bearbeitungszentren von elumatec, Haffner, Handtmann, HEFI, Rapid, Schirmer, Stürtz, etc.

Waterslot cutter -solid carbide-

Single flute, spiral

- special version for CNC-machines - with drill point 90°
- for machining-centres as elumatec, Haffner, Handtmann, HEFI, Rapid, Schirmer, Stürtz, etc.

Art.-Nr.	A	B	C	D	E
080 705 405	5	40		80	5
060 708 095	5	20		60	8
080 708 395	5	30		80	8
080 708 405	5	40		80	8
090 708 395	5	30		90	8
090 718 395	5	35	55	90	8
010 718 395	5	35	55	100	8
080 706 406	6	40		80	6
090 706 456	6	45		90	6
010 718 906	6	35	72	110	8

HSSE oder VHM:

...perfekte Wasserschlitze – für alle Anwendungsfälle den optimalen Fräser

HSS-E or solid carbide:

...perfect waterslots – for all scope the suitable drainage cutter



Wasserschlitzfräser VHM

91122

Einschneidig, spiralg

VHM-Schneide in **Stahlschaft 8 mm**

Zur PVC-Bearbeitung

Waterslot cutter -solid carbide-

Single flute, spiral

solid carbide cutting edge with steel shank 8 mm

For UPVC-working

Art.-Nr.	A	B	C	D	E
060 808 005	5	20		60	8
080 808 005	5	20	35	80	8
090 808 005	5	20	45	90	8
090 808 345	9	34	45	90	8
090 808 305	5	30		90	8
011 808 495	5	40	50	90	8
090 808 405	5	40	55	90	8
011 808 305	5	30	45	100	8
011 808 405	5	40	50	100	8
020 808 005	5	45	60	120	8

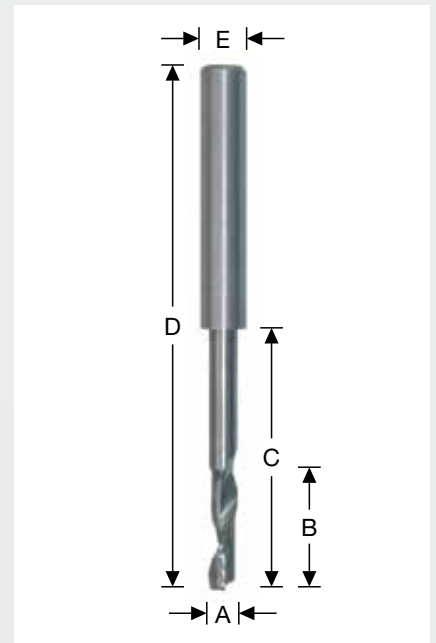

Wasserschlitzfräser VHM

91123

Zweischneidig mit Bohrerspitze 90°

für Bearbeitungszentren von elumatec, Haffner, Handtmann, HEFI, Rapid, Schirmer, Stürtz, etc.

Waterslot cutter -solid carbide-

Two flutes with drill point 90°

for machining-centres as elumatec, Haffner, Handtmann, HEFI, Rapid, Schirmer, Stürtz, etc.

Art.-Nr.	A	B	D	E
014 705 005	5	40	80	5
014 705 405	5	40	100	5
014 708 265	5	20	60	8
014 708 375	5	30	70	8
014 708 405	5	40	80	8
014 708 205	5	20	85	8
014 708 305	5	30	90	8
014 708 415	5	40	100	8
014 708 455	5	45	100	8
014 708 406	6	40	75	8
014 708 496	6	40	95	8
014 708 306	6	30	90	8
014 708 456	6	45	90	8
014 708 658	8	65	100	8

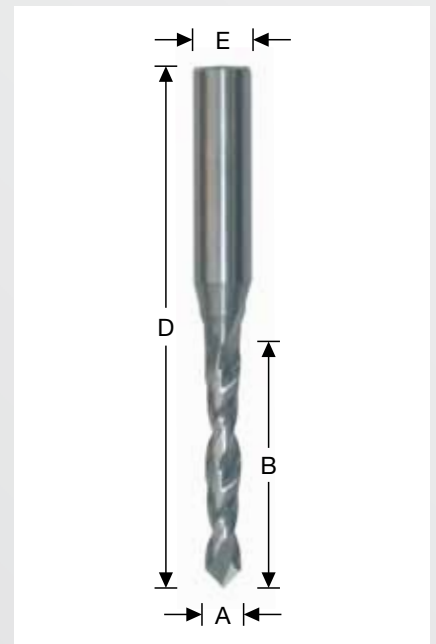

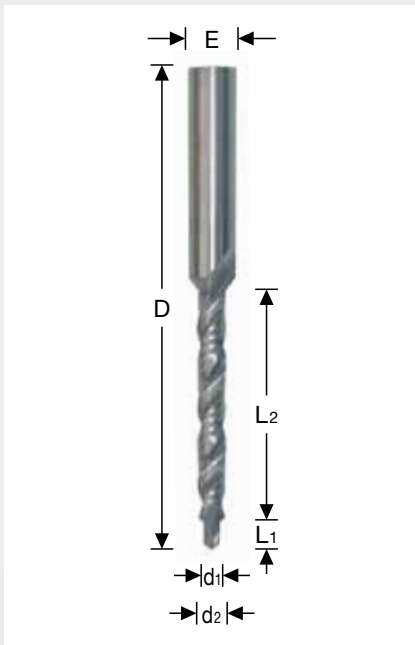

Stufenfräser VHM

91124

Zweischneidig

für Bearbeitungszentren von elumatec, Haffner, Rapid, Stürtz, etc.
Für PVC-Bearbeitung

Stepped cutter -solid carbide-

Two flutes

for machining-centres as elumatec, Haffner, Rapid, Stürtz, etc.
For UPVC-working

Art.-Nr.	d1	l1	d2	l2	D	E
922 083 433	2,0	4,5	5	20	60	8
922 083 447	2,5	4,5	5	20	60	8
922 083 432	2,5	4,5	5	30	70	8
922 083 441	3	4,5	5	20	60	8
922 083 425	3	4,5	5	30	70	8
922 083 450	3	5,5	5	30	70	8
922 083 426	3	4,5	5	40	80	8
922 083 540	3	5,5	5	40	100	8
922 083 440	4	10	5	40	80	8
954 505 004	4	20	8	57	100	8

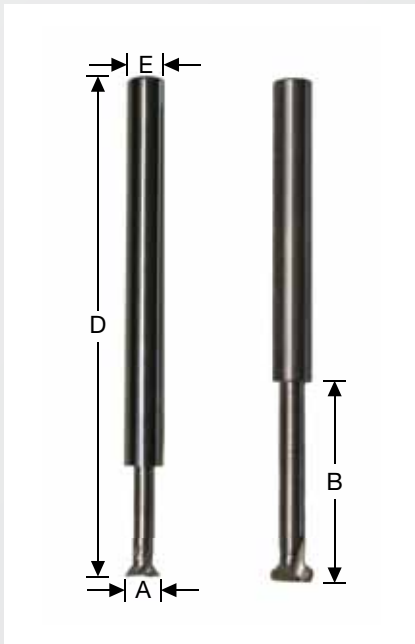

T-Nutenfräser VHM

91125

zum Verputzen der Innenecken
- für Bearbeitungszentren von elumatec, Rotox, Stürtz, Urban
- weitere Typen & Abmessungen lieferbar

T-slot cutter solid carbide

for inside corner cleaning
- for machining-centres as elumatec, Rotox, Stürtz, Urban
- various types and sizes available

Art.-Nr.	A	B	D	E	Z/T
010 788 090	8	20	100	8	4
273 513 210	8	30	100	8	2
273 513 090	9	50	100	8	2
273 513 110	10	25	100	8	8
273 513 120	12	45	100	8	2
273 515 180	12	50	100	8	2
273 513 100	14	45	100	8	2

Einschneidig, spiralg

VHM-Schneide in **Stahlschaft 8 mm**

für Bearbeitungszentrum AFS, BJM, Rotox, Schirmer

P1 = Rechtslauf / Rechtsdrall

P2 = Rechtslauf / Linksdrall

P3 = Rechtslauf / Rechtsdrall + Vorbohrer 2,7x5

P4 = Rechtslauf / Linksdrall + Vorbohrer 2,7x5

Waterslot cutter -solid carbide-

Single flute, spiral

solid carbide, cutting edge with steel shank 8 mm

for AFS, BJM, Rotox, Schirmer CNC-machining-centre

P1 = RH cut / RH spiral

P2 = RH cut / LH spiral

P3 = RH cut / RH spiral + step 2,7x5

P4 = RH cut / LH spiral + step 2,7x5

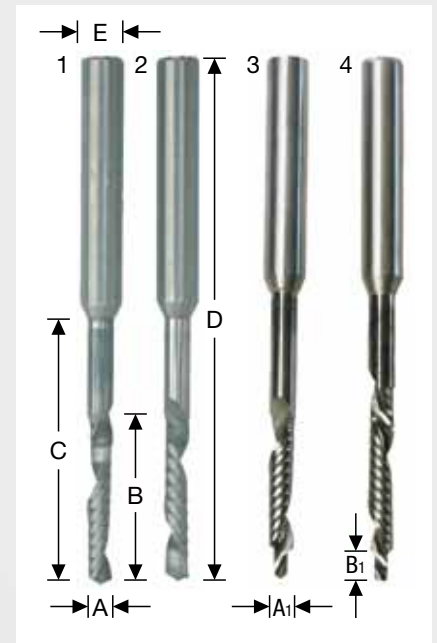

Art.-Nr.	A	B	C	D	E	P
080 838 255	2,7/5	25		80	8	3
010 838 305	2,7/5	30	50	100	8	3
080 808 255	5	25		80	8	1
090 808 345	5	34	45	90	8	1
010 808 305	5	30	50	100	8	1
080 848 305	2,7/5	25		80	8	4
010 848 305	2,7/5	30	50	100	8	4
080 828 255	5	25		80	8	2
080 828 355	5	35		80	8	2
010 828 305	5	30	50	100	8	2

HSSE oder VHM:

...perfekte Wasserschlitze – für alle Anwendungsfälle den optimalen Fräser

HSS-E or solid carbide:

...perfect waterslots – for all scope the suitable drainage cutter

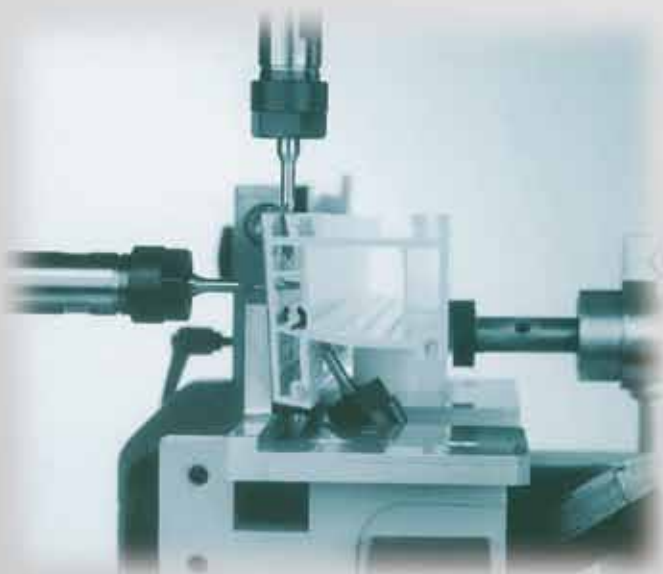

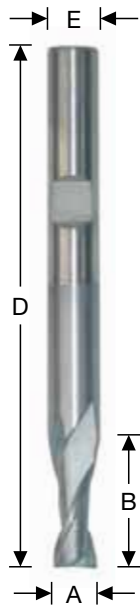

Schafffräser VHM

91131

für **Stahlbearbeitung** mit **Spezialbeschichtung**

Zweischneidig, spiralig

verwendbar auf Kopierfräsen und Bearbeitungszentren, z.B. Schüco

Milling cutter -solid carbide-

for **steel working - special coated**

Two flutes, spiral

for copy routers and high speed router machines, as Schüco

Art.-Nr.	A	B	D	E
182 706 004	4	10	57	6
182 706 005	5	10	57	6
182 706 006	6	10	57	6
182 708 008	8	16	63	8
182 710 010	10	19	72	10

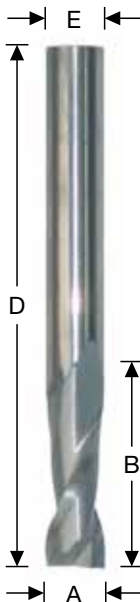

Bohrnutenfräser VHM

91140

Universal einsetzbar, für alle Bearbeitungszentren

Zweischneidig, spiralig

Milling cutter -solid carbide-

All-purpose tool, for all kind of CNC-machines

Two flutes, spiral

Art.-Nr.	A	B	C	D	E
058 706 025	2,5	8		58	6
082 705 305	5	30		70	5
082 718 206	6	20	60	120	8
082 706 406	6	40		100	6
082 708 608	8	18		60	8
082 708 008	8	35		80	8
082 708 108	8	40		100	8
082 708 708	8	70		150	8
082 711 008	8	35	42	100	10
082 710 210	10	22		72	10
140 391 210	10	12	60	90	10
082 710 010	10	40		100	10
140 392 210	10	12	80	110	10
082 710 710	10	70		150	10
082 712 212	12	22		70	12
140 391 212	12	12	60	100	12
082 712 412	12	45		100	12
082 712 512	12	40		120	12
082 714 414	14	45		100	14
140 390 216	16	22		70	16
082 716 416	16	45		100	16
140 391 316	16	32	60	102	16
140 391 317	16	35	70	110	16
082 716 216	16	20	60	115	16
082 716 116	16	70		150	16

Zur Bearbeitung von Aluminiumprofilen auf CNC Bearbeitungszentren

- höchste Präzision
- sehr hohe Schnittgeschwindigkeit
- hervorragende Standzeit

Milling cutter -solid carbide- HSC-roughing „ZR“-

Special version for high-speed cutting/HSC of aluminium extrusions on CNC-machining centres

- highest precision
- more speed and feed
- extremely long life

Art.-Nr.	A	B	C	D	E	Z/T
057 744 002	2	10		57	6	3
057 744 003	3	15	23	57	6	3
057 744 004	4	15	23	57	6	3
057 744 005	5	15	23	57	6	3
057 744 006	6	15	23	57	6	3
072 744 008	8	22		72	8	3
072 744 010	10	25		72	10	3
080 744 012	12	30		80	12	3
010 744 016	16	30	50	100	16	4

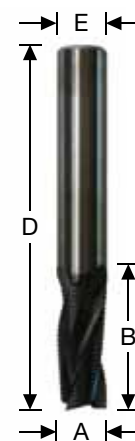



Spiralbohrer HSS

91201

DIN 338 N **-geschliffen-**

Präzisionsausführung, Weitere Abmessungen auf Anfrage

Twist drill HSS

DIN 338 N -fully ground-, short, precision, Other dimensions upon demand

Art.-Nr.	A	B	D
303 001 020	2,0	24	49
303 001 025	2,5	30	57
303 001 030	3,0	33	61
303 001 032	3,2	36	65
303 001 035	3,5	39	70
303 001 040	4,0	43	75
303 001 042	4,2	43	75
303 001 045	4,5	47	80
303 001 050	5,0	52	86
303 001 055	5,5	57	93
303 001 060	6,0	57	93
303 001 065	6,5	63	101
303 001 070	7,0	69	109
303 001 075	7,5	69	109
303 001 080	8,0	75	117
303 001 085	8,5	75	117
303 001 090	9,0	81	125
303 001 100	10,0	87	133
303 001 110	11,0	94	142
303 001 120	12,0	101	151
303 001 130	13,0	101	151
303 001 140	14,0	108	160
303 001 150	15,0	114	169

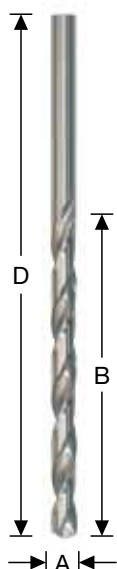

Spiralbohrer HSS

91211

DIN 340 N **-geschliffen-** Präzisionsausführung

Twist drill HSS

DIN 340 N -fully ground-, long, precision

Art.-Nr.	A	B	D
302 002 020	2,0	56	85
302 002 025	2,5	62	92
302 002 030	3,0	66	100
302 002 032	3,2	69	106
302 002 035	3,5	73	112
302 002 040	4,0	78	119
302 002 042	4,2	78	119
302 002 045	4,5	82	126
302 002 050	5,0	87	132
302 002 055	5,5	91	139
302 002 060	6,0	91	139
302 002 065	6,5	97	148
302 002 070	7,0	102	156
302 002 075	7,5	102	156
302 002 080	8,0	109	165
302 002 085	8,5	109	165
302 002 090	9,0	115	175
302 002 095	9,5	115	175
302 002 100	10,0	121	184

Spiralbohrer HSS

91221

DIN 1897 **-geschliffen-**
- kurze Ausführung

Twist drill HSS

DIN 1897 **-fully ground-**, short, precision

Art.-Nr.	A	B	D
303 004 050	5,0	26	62
303 004 060	6,0	28	66
303 004 080	8,0	37	79
303 004 100	10,0	43	89
303 004 110	11,0	47	95
303 004 120	12,0	51	102
303 004 130	13,0	51	102

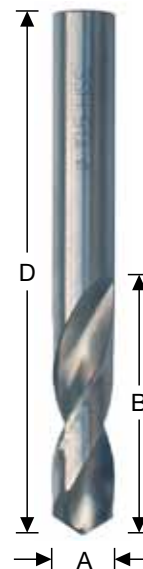

Spiralbohrer HSS-G

91225

DIN 1869 **-geschliffen-**
- Präzisionsausführung
- überlange Ausführung, Tieflochspirale

Twist drill HSS-G

DIN 1869 **-fully ground-**, extra long, precision

Art.-Nr.	A	B	D
303 008 020	2,0	85	125
303 008 025	2,5	95	140
303 008 030	3,0	100	150
303 008 032	3,2	105	155
303 008 035	3,5	115	165
303 008 040	4,0	120	175
303 008 042	4,2	120	175
303 008 045	4,5	125	185
303 008 050	5,0	135	195
303 008 055	5,5	140	205
303 008 060	6,0	140	205
303 008 065	6,5	150	215
303 008 070	7,0	155	225
303 008 075	7,5	155	225
303 008 080	8,0	165	240
303 008 085	8,5	165	240
303 008 090	9,0	175	250
303 008 095	9,5	175	250
303 008 100	10,0	185	265
303 008 105	10,5	185	265
303 008 110	11,0	195	280
303 008 115	11,5	195	280
303 008 120	12,0	205	295
303 008 130	13,0	205	295

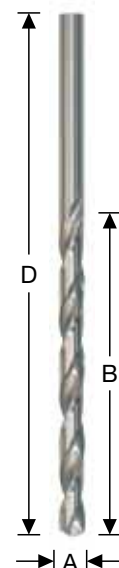

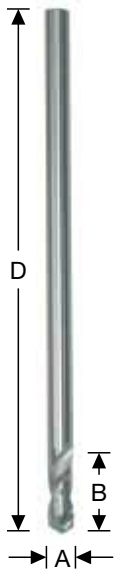

Spezialbohrer **-geschliffen-**

- zum Bohren von Stahlprofilblech-Konstruktionen und Fensterprofilen
- extra kurze Spirale, geringe Bruchgefahr

Window construction twist drill HSS

Special drill **-fully ground-**

- extra short flute, break-proof

Art.-Nr.	A	B	D	
306 100 030	3,0	30	100	
306 100 040	4,0	30	100	
306 150 050	5,0	30	150	
306 150 055	5,5	30	150	
306 150 060	6,0	30	150	
306 150 065	6,5	30	150	
306 150 100	10,0	30	150	
306 150 105	10,5	30	150	
306 180 050	5,0	30	180	
306 180 055	5,5	30	180	
306 180 060	6,0	30	180	
306 180 065	6,5	30	180	
306 180 080	8,0	30	180	
306 180 085	8,5	30	180	
306 180 100	10,0	30	180	
306 180 105	10,5	30	180	
306 180 265	6,5	30	180	Spanbrecher / chip-breaker
306 180 280	8,0	30	180	Spanbrecher / chip-breaker
306 180 210	10,0	30	180	Spanbrecher / chip-breaker
306 180 215	10,5	30	180	Spanbrecher / chip-breaker

Präzisions-Spiralbohrer und Stufenbohrer werden aus dem Vollen geschliffen – das garantiert höchste Rundlaufgenauigkeit



Precision twist drills and stepped drills are ground from solid stock – this method guarantees best possible diameter tolerances and precision

Spiralbohrer HSS CO

91230

DIN 338 -Kobalt legiert-, **-geschliffen-**
Mehrbereichs- / Hochleistungs-Spezialbohrer

Twist drill HSS CO

DIN 338 -cobalt-, **-fully ground-**, precision
Jobber drills, heavy duty, all purpose tool

Art.-Nr.	A	B	D
303 007 020	2,0	24	49
303 007 025	2,5	30	57
303 007 030	3,0	33	61
303 007 032	3,2	36	65
303 007 035	3,5	39	70
303 007 040	4,0	43	75
303 007 042	4,2	43	75
303 007 045	4,5	47	80
303 007 050	5,0	52	86
303 007 055	5,5	57	93
303 007 060	6,0	57	93
303 007 062	6,2	63	101
303 007 065	6,5	63	101
303 007 070	7,0	69	109
303 007 075	7,5	69	109
303 007 080	8,0	75	117
303 007 085	8,5	75	117
303 007 090	9,0	81	125
303 007 100	10,0	87	133
303 007 110	11,0	94	142
303 007 120	12,0	101	151
303 007 130	13,0	101	151

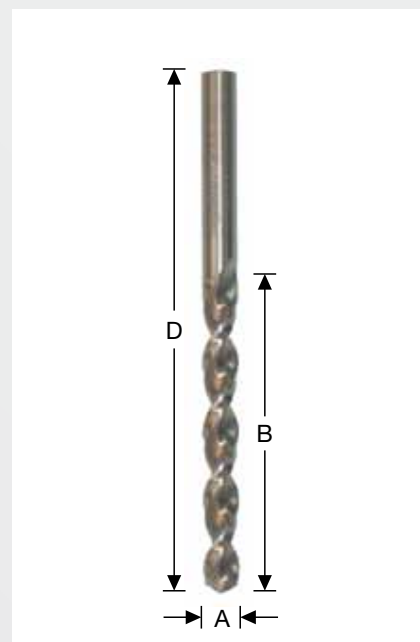

Spiralbohrer HSS CO

91232

DIN 340 -Kobalt legiert-, **-geschliffen-**
Mehrbereichs- / Hochleistungs-Spezialbohrer

Twist drill HSS CO

DIN 340 -cobalt-, **-fully ground-**, precision
Jobber drills, heavy duty, all purpose tool

Art.-Nr.	A	B	D
303 009 030	3,0	62	95
303 009 032	3,2	69	106
303 009 035	3,5	73	112
303 009 040	4,0	78	119
303 009 042	4,2	78	119
303 009 045	4,5	82	126
303 009 050	5,0	87	132
303 009 055	5,5	91	139
303 009 060	6,0	97	139
303 009 065	6,5	97	148
303 009 070	7,0	102	156
303 009 080	8,0	109	165
303 009 090	9,0	115	175
303 009 100	10,0	121	184

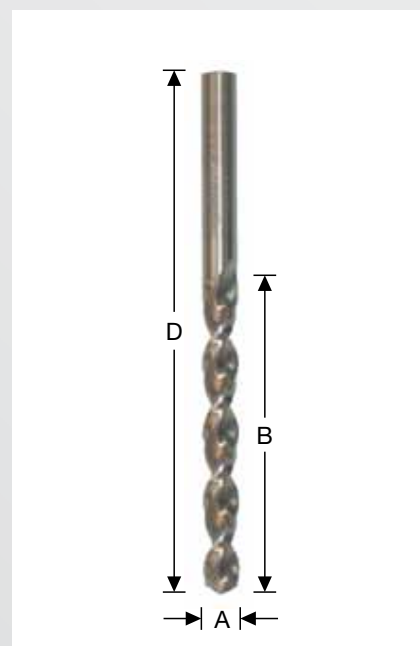

Stufenbohrer HSS

91250

zur Bearbeitung von Aluminium- und Kunststoffprofilen

Winkel 180° (für Zylinderkopfschraube)

Weitere Abmessungen und Ausführungen kurzfristig auf Anfrage lieferbar !

Step drill bits HSS

for working aluminium and UPVC-profiles

Angle 180° (for cylinder head screw)

Other sizes and types are shortly available upon demand !

Art.-Nr.	A	B	C	D	
301 008 004	4,3	8,0	11	117	180°
301 010 005	5,3	10,0	13	133	180°
301 104 053	5,3	10,4	10	133	180°
301 012 006	6,4	12,0	15	151	180°
301 120 700	7,0	12,0	10	151	180°
301 012 008	8,0	12,0	15	151	180°
301 130 800	8,0	13,0	10	151	180°



Stufenbohrer HSS

91260

zur Bearbeitung von Aluminium- und Kunststoffprofilen

Winkel 90° (für Senkschraube)

* kurze Ausführung für Bearbeitungszentren

Weitere Abmessungen und Ausführungen kurzfristig auf Anfrage lieferbar !

Step drill bits HSS

for working aluminium and UPVC-profiles

Angle 90° (for cheese head screw)

* short version for CNC-machines

Other sizes and types are shortly available upon demand !

Art.-Nr.	A	B	C	D	
301 108 004	4,3	8,0	11	117	90°
301 111 005	5,0	11,0	6	142	90°
301 112 005	5,0	12,0	20	100	90°
301 110 005	5,3	10,0	13	133	90°
301 112 006	6,4	12,0	15	151	90°
301 208 004*	4,3	8,0	11	79	90°
301 210 005*	5,3	10,0	13	89	90°
301 210 006*	6,4	12,0	15	102	90°



Schaft 8 mm mit Fläche
Winkel 90°

R = Rechtslauf - L = Linkslauf

Drills for handle hole, HSS Co, piloted

cylindric shank 8 mm with flat
Angle 90°

R = RH-rotation - L = LH-rotation

Art.-Nr.	A	C	B	D	E	
301 207 055	5,5	7	11	107	8	R
301 210 055	5,5	7	11	110	8	R
301 210 155	5,5	7	12	115	8	L
301 210 255	5,5	7	11	115	8	R
301 212 255	5,5	7	12	120	8	L
301 310 155	5,5	7	13	115	8	L
301 212 355	5,5	7	12	115	10	R
301 210 455	5,5	7	10	110	10	L

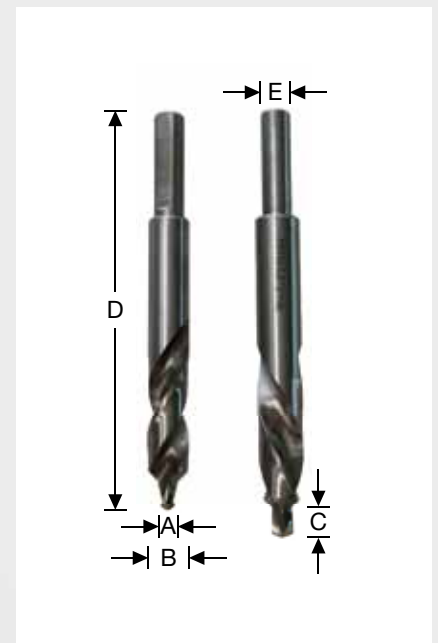

**Olivenbohrer für 3-Spindelbohrköpfe
 mit Gewinde oder Zylinder-Schaft**



***Drills for triple-drill units
 with male thread or cylindric plain shank***

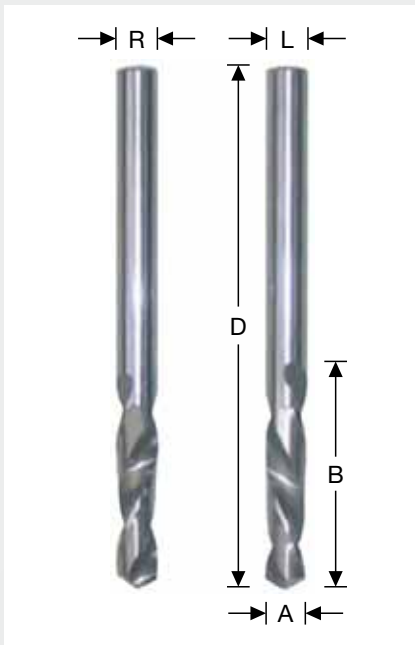

Spiralbohrer VHM

91262

durchgehend zylindrisch, **Dachformspitze**.

Universalbohrer zum Einsatz auf Bearbeitungszentren für höchste Ansprüche und Standzeiten in Holz, PVC, Aluminium, GFK, Stahl, etc.

R = Rechtslauf - L = Linkslauf

Brad point drill -solid carbide-

cylindrical on the whole length, with taper drill point. All purpose drill.

For use in CNC-machining centres, for best results in wood, UPVC, aluminium, glassfiber, steel, etc.

R = RH-rotation - L = LH-rotation

Art.-Nr.	A	B	D	
484 000 002	2,0	12	38	R
484 000 025	2,5	14	43	R
484 000 003	3,0	16	46	R
484 001 030	3,0	27	46	R
484 000 035	3,5	20	52	R
484 000 004	4,0	22	55	R
484 000 045	4,5	24	58	R
484 000 005	5,0	26	62	R
484 000 006	6,0	28	66	R
484 000 008	8,0	37	79	R
485 000 002	2,0	12	38	L
485 000 025	2,5	14	43	L
485 000 003	3,0	16	46	L
485 001 030	3,0	27	46	L
485 000 035	3,5	20	52	L
485 000 004	4,0	22	55	L
485 000 045	4,5	24	58	L
485 000 005	5,0	26	62	L



Mehrstufenbohrer HSS

91265

für gratfreies Bohren und Aufreiben von Blechen, Rohren und Profilen

C = Abstufung

Multi Step drill HSS

All purpose step drill for sheet metal, tubes and profiles

C = Stepped

Art.-Nr.	A	B	C	E
304 000 001	4	12	1	6
304 000 002	6	20	2	8
304 000 003	6	30	2	8

Kegel- und Entgratsenker 90° HSS + VHM

91266

dreischneidig, rechtsschneidend, Zylinderschaft

Counter sinks 90° HSS + tungsten carbide

three flutes, RH, cylindric shank

Art.-Nr. HSS	Art.-Nr. VHM/TC	A	B	E
310 004 043	-	4,3	1,5	4
310 005 050	-	5,0	2,0	5
310 005 053	-	5,3	2,0	5
310 006 060	-	6,0	2,0	6
310 006 063	310 705 063	6,3	2,0	6
310 006 070	-	7,0	3,0	6
310 006 073	-	7,3	3,0	6
310 006 080	-	8,0	3,0	6
310 006 083	310 706 083	8,3	3,0	6
310 006 094	-	9,4	4,0	6
310 006 100	-	10,0	4,0	6
310 006 104	310 706 104	10,4	4,0	6
310 008 115	-	11,5	4,0	8
310 008 124	310 708 124	12,4	4,0	8
310 008 134	-	13,4	5,0	8
310 008 150	-	15,0	5,0	8
310 010 165	310 710 165	16,5	5,0	10
310 010 190	-	19,0	5,0	10
310 010 205	310 710 205	20,5	5,0	10
310 012 230	-	23,0	6,0	10
310 012 250	310 710 250	25,0	6,0	10
310 012 280	-	28,0	7,0	12
310 012 310	310 712 310	31,0	7,0	12



Kegel- und Entgratsenker mit Querloch

91267

Senkwinkel 90°

Zum Entgraten von Bohrungen

Counter sinks with cross-hole

90° zero flute
to deburr drill holes

Art.-Nr.	A	E
311 000 002	2/5	6
311 000 005	5/10	8
311 000 010	10/15	10
311 000 015	15/20	12
311 000 020	20/25	12
311 000 025	25/30	15



Kombi-Maschinengewindebohrer HSS-E

91268

zum Kernlochbohren, Gewindeschneiden und Entgraten in **EINEM** Arbeitsgang

Combined machine taps HSS-E

to drill cored hole, thread cutting and deburr in **ONE** operation

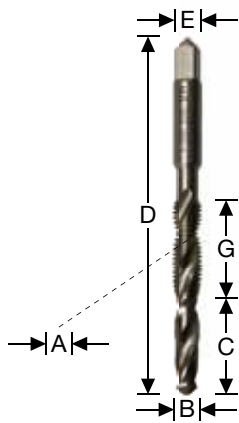

Art.-Nr.	A	B	C	G	D	E
312 000 003	M3	2,5	16	11	56	3,0
312 000 004	M4	3,3	18	14	63	4,0
312 000 005	M5	4,2	20	18	71	5,0
312 000 006	M6	5,0	22	22	80	6,0
312 000 008	M8	6,8	26	25	95	8,0
312 000 010	M10	8,5	30	31	106	10,0
312 000 012	M12	10,2	32	35	115	12,0

Lochsäge HM-bestückt

91269

5 HM-Spezialzähne für PVC-/ Stahlbearbeitung auf Bearbeitungszentren THORWESTEN
alte Version -auslaufend-

Hole drill TCT

5 tungsten carbide special teeth for UPVC/ steel reinforcement working on
CNC machine THORWESTEN
old version -discontinued-



Art.-Nr.	A	D	E
304 000 020	20	91	10
304 000 024	24	91	10

Spezial-Stufenbohrer – THORWESTEN –

91270

für PVC-/ Stahlbearbeitung auf Bearbeitungszentren THORWESTEN
neue Version

Special stepped drill

for UPVC/ steel reinforcement working on CNC machine THORWESTEN
new version



Art.-Nr.	A	D	E
304 007 020	20	100	16

**CNC-Werkzeughalter für Bearbeitungszentren
HSK / ISO / SK**

*CNC-holder for CNC centres
HSK / ISO / SK*



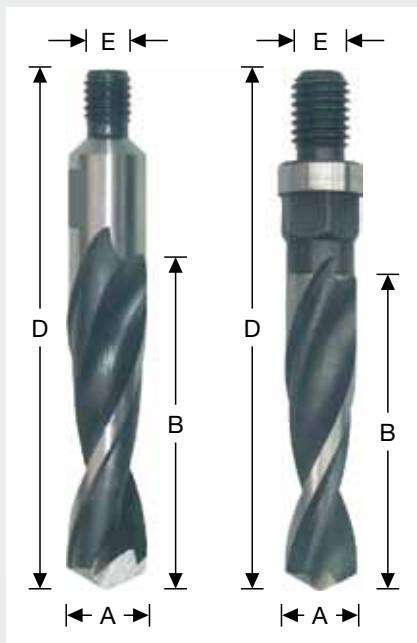

Olivenbohrer HSS-E

91300

mit **Dachformspitze**, Aussengewinde, **Rechtslauf**

Zur Bearbeitung von Kunststoffprofilen mit oder ohne Stahleinlage.

Threaded drill HSS-E

with **taper drill point**, male thread, **RH-rotation**

For working of UPVC profiles with or without filling steel profile

Art.-Nr.	A	B	D	E
492 050 010	10	50	87	M6 Konus/cone
488 030 010	10	30	65	M10
482 050 010	10	45	78	M8 Konus/cone
496 050 010	10	30	76	M10
480 050 010	10	50	87	M10
480 080 010	10	80	113	M10
492 050 012	12	50	87	M6 Konus/cone
482 050 012	12	45	78	M8 Konus/cone
488 030 012	12	30	65	M10
496 050 012	12	30	76	M10
480 050 012	12	50	87	M10
480 080 012	12	80	113	M10
492 050 014	14	50	87	M6 Konus/cone
482 050 014	14	45	78	M8 Konus/cone
488 030 014	14	30	65	M10
496 050 014	14	30	76	M10
480 050 014	14	50	87	M10
480 080 014	14	80	113	M10

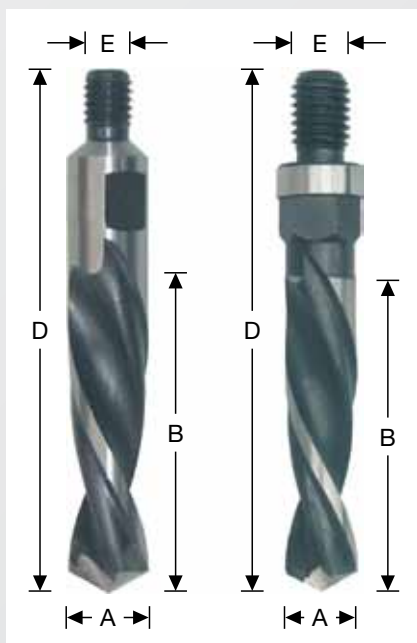

Olivenbohrer HSS-E

91301

mit **Dachformspitze**, Aussengewinde, **Linkslauf**

Zur Bearbeitung von Kunststoffprofilen mit oder ohne Stahleinlage.

Threaded drill HSS-E

with **taper drill point**, male thread, **LH-rotation**

For working of UPVC profiles with or without filling steel profile

Art.-Nr.	A	B	D	E
483 050 010	10	45	78	M8 Konus/cone
489 030 010	10	30	60	M10
497 050 010	10	30	72	M10
481 050 010	10	50	87	M10
481 080 010	10	80	113	M10
483 050 012	12	45	78	M8 Konus/cone
489 030 012	12	30	60	M10
497 050 012	12	30	72	M10
481 050 012	12	50	87	M10
481 060 010	10	60	100	M10
481 080 012	12	80	113	M10
483 050 014	14	45	78	M8 Konus/cone
481 060 012	12	60	100	M10
489 030 014	14	30	60	M10
497 050 014	14	30	72	M10
481 050 014	14	50	87	M10
481 080 014	14	80	113	M10

Olivenbohrer HSS-E

91310

mit **Vorböhrer**, Aussengewinde, **Rechtslauf**
Zur Bearbeitung von Kunststoffprofilen mit oder ohne Stahleinlage.

Threaded drill HSS-E

piloted version, male thread, RH-rotation

For working of UPVC profiles with or without filling steel profile

Art.-Nr.	A	B	D	E
490 050 010	10	45	78	M8 Konus/cone
494 030 010	10	30	65	M10
476 030 010	10	35	76	M10
486 150 010	10	50	84	M10
486 050 010	10	50	87	M10
486 060 010	10	60	100	M10
486 080 010	10	80	113	M10
490 050 012	12	45	78	M8 Konus/cone
494 030 012	12	30	65	M10
476 030 012	12	30	76	M10
486 150 012	12	50	84	M10
486 050 012	12	50	87	M10
486 060 012	12	60	100	M10
486 080 012	12	80	113	M10
490 050 014	14	45	78	M8 Konus/cone
494 030 014	14	30	65	M10
476 030 014	14	30	76	M10
486 150 014	14	50	84	M10
486 050 014	14	50	87	M10
486 080 014	14	80	113	M10

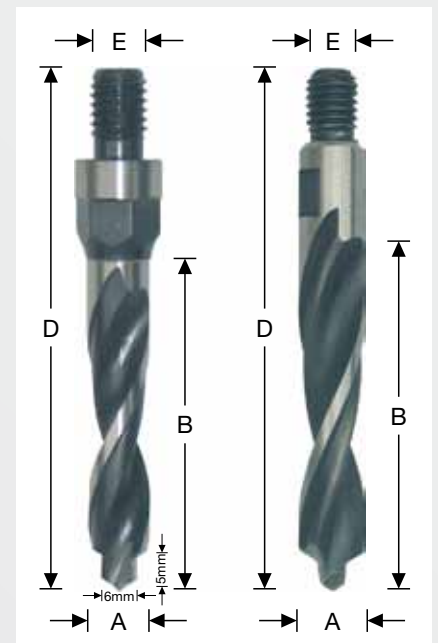

Olivenbohrer HSS-E

91311

mit **Vorböhrer**, Aussengewinde, **Linkslauf**
Zur Bearbeitung von Kunststoffprofilen mit oder ohne Stahleinlage.

Threaded drill HSS-E

piloted version, male thread, LH-rotation

For working of UPVC profiles with or without filling steel profile

Art.-Nr.	A	B	D	E
491 050 010	10	45	78	M8 Konus/cone
495 030 010	10	30	60	M10
477 030 010	10	35	72	M10
487 050 010	10	50	87	M10
487 060 010	10	60	100	M10
487 080 010	10	80	113	M10
491 050 012	12	45	78	M8 Konus/cone
495 030 012	12	30	60	M10
477 030 012	12	35	72	M10
487 050 012	12	50	87	M10
487 060 012	12	60	100	M10
487 080 012	12	80	113	M10
491 050 014	14	45	78	M8 Konus/cone
495 030 014	14	30	65	M10
477 030 014	14	35	72	M10
487 050 014	14	50	87	M10
487 060 014	14	60	100	M10
487 080 014	14	80	113	M10

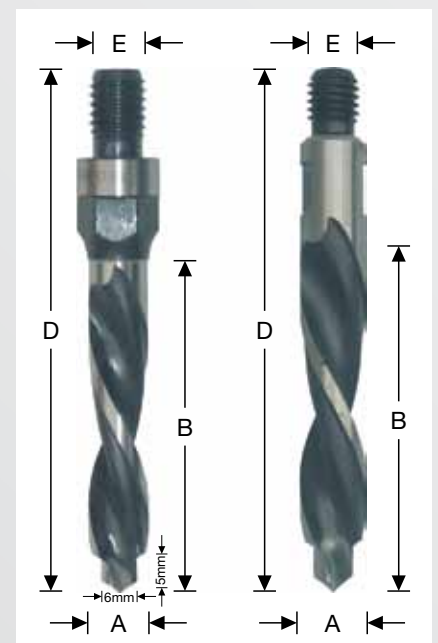

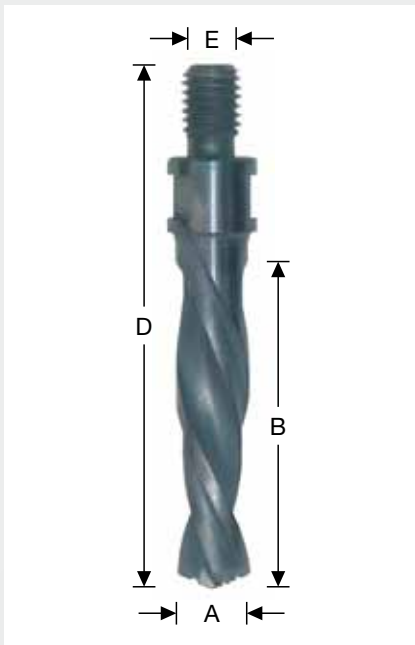

Olivenbohrer HSS-E

91315

- mit zusätzlichen **Spanbrechern und Spezialbeschichtung** für Stahl
 - mit **Dachformspitze** und Aussengewinde M10 Rechts / Links
 - für Bearbeitungszentren
- R = Rechtslauf - L = Linkslauf

Threaded drill HSS-E

- with **additional chip breaker and special coating** for steel
 - with **taper drill point** and Male screw M10
 - used on CNC-machining centres
- R = RH-rotation - L = LH-rotation

Art.-Nr.	A	B	D	E	
498 050 010	10	50	87	M10	R
498 050 012	12	50	87	M10	R
498 050 014	14	50	87	M10	R
498 060 010	10	60	97	M10	R
498 060 012	12	60	97	M10	R
498 060 013	13	60	97	M10	R
499 050 010	10	50	87	M10	L
499 050 012	12	50	87	M10	L
499 050 014	14	50	87	M10	L
499 060 010	10	60	97	M10	L

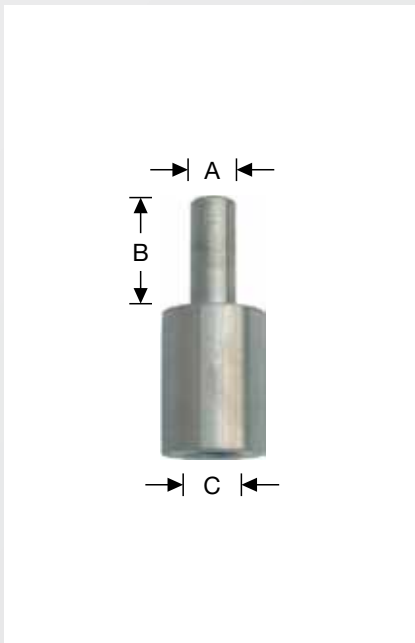

Aufnahme für Bohrer mit Außengewinde

91316

Zur Verwendung Bohrer Gruppe 91300-91315
in Standard-Bohrfutter
R = Rechtslauf - L = Linkslauf

Plain shank bits

for use drills group 91300-91315
in standard drill chuck
R = RH-rotation - L = LH-rotation

Art.-Nr.	A	B	C	
478 008 008	8	20	M8	R
479 008 008	8	20	M8	L
478 008 010	8	20	M10	R
479 008 010	8	20	M10	L
478 010 010	10	20	M10	R
479 010 010	10	20	M10	L

Diamant-Frässtifte

91500

für die Kunststoff-Fenster-Fertigung
passend zu Druckluft-Dichtnutenfräse 95202 / 95205

Diamond-Tools

for the UPVC window production
fits to pneumatic dentist drill 95202 / 95205

Art.-Nr.	A	B	D	E	Abb.
000 562 501	3	6	40	3	1
000 562 502	4	6,5	40	3	1
000 562 503	5	7	40	3	1
000 562 511	3	7	40	3	2
000 562 512	4	7	40	3	2

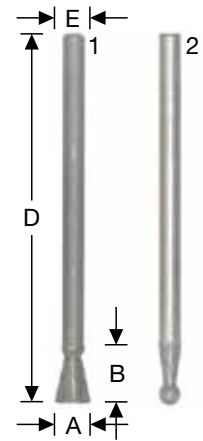

Frässtifte für Dichtnutfräsen

91600

passend zu 95202 / 95203 / 95207

Router bit for pneumatic tools

suitable for 95202 / 95203 / 95207

Art.-Nr.	A	D	Form		Mat.
037 003 003	3	40	Kugel	ball	HSS
037 003 004	4	40	Kugel	ball	HSS
040 003 003	3	40	Zylinder	cylinder	VHM
040 004 004	4	40	Zylinder	cylinder	VHM

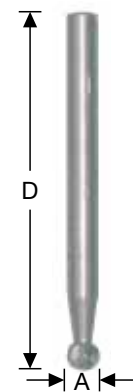

ALUCOBOND-Bearbeitung

91900

V-Nutfräser für Oberfräse / CNC-Fräse

ALUCOBOND

V-Grooving bits for hand routers / CNC-machines

Art.-Nr.	A	B	C	E
054 372 503	6		4	4
054 372 504	8		4	4
054 372 506	10	95°		10
054 372 501	15,9	90°		8
054 372 502	18	135°		8
054 372 507	10	90°		10
054 372 508	10	135°		10

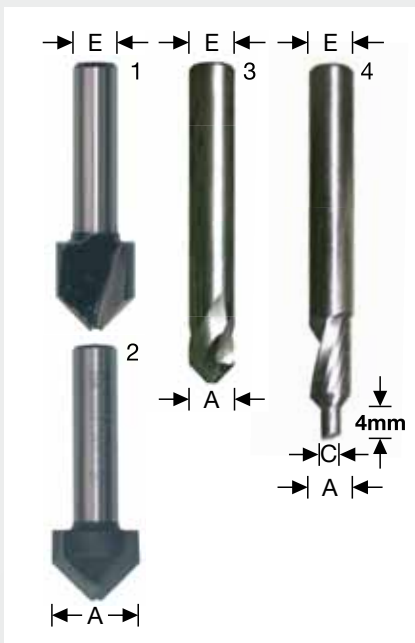

Scheibenfräser HM-bestückt für ALUCOBOND

91901

für Plattensägen und-fräsen

Carbide-tipped grooving cutters for ALUCOBOND

for sheet milling machines

Art.-Nr.	A	B	C	Breite	
700 118 200	118	20	135°	18 mm	
700 118 201	118	20	90°	14 mm	
700 220 300	220	30	90°	14 mm	
700 220 301	220	30	135°	18 mm	
700 244 301	244	30	90°	14 mm	
700 244 300	244	30	135°	18 mm	

mit HM-Wendepplatten

with TC insert / turn-over knives

713 244 300	244	30	90°	Breite	16,5 mm
-------------	-----	----	-----	--------	---------

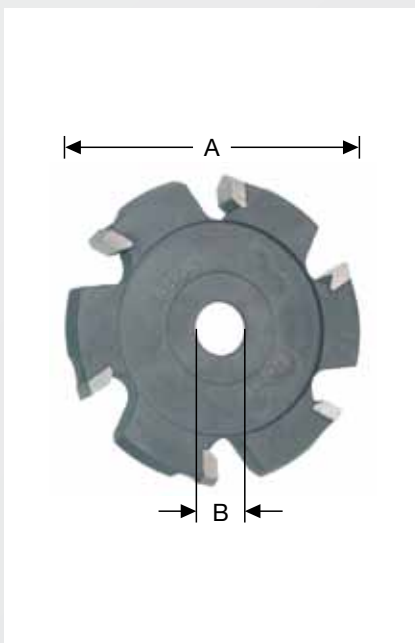

Kreissägeblätter HM-bestückt für ALUCOBOND

91902

für Plattensägen
HOLZHER / Striebig

Carbide-tipped sawblade for ALUCOBOND

for sheet cutting machines
Holzher / Striebig

Art.-Nr.	A	B	C	Z
721 250 300	250	3,2	30	60
721 300 300	300	3,2	30	72
721 300 301	300	3,2	30	96

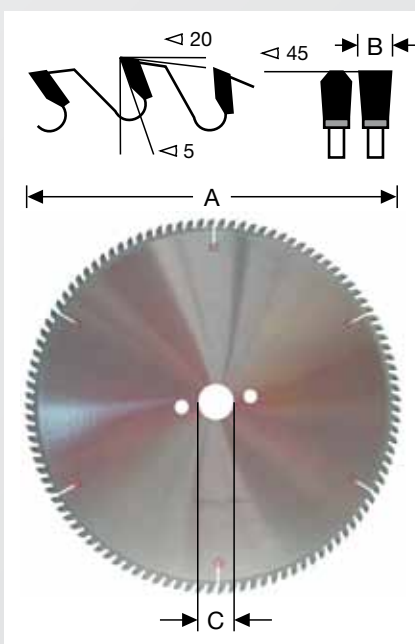



Kooperationspartner



ALUCOBOND®

ALUCORE®

DIBOND®

Kreissägeblätter HM-bestückt -negativ-

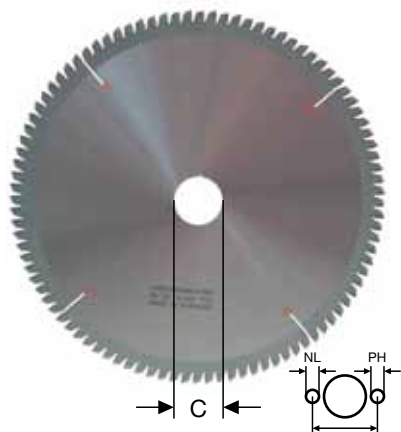
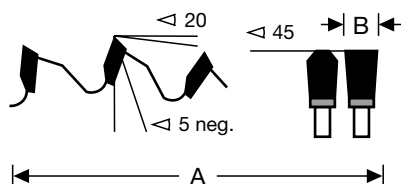

Flach-Trapez-Zahn, geräuschgedämpft,

- für Profile und Vollmaterial aus Aluminium, Kunststoff und NE-Metallen
- zum Einsatz auf **Kappsägen / Zugsägen (Sägeblatt von oben)**

Weitere Abmessungen auf Anfrage

Carbide-tipped sawblades -negative rake-

TCG, noise reduced,

- for profiles of aluminium and plastics

- used on **chop-mitre saws**

Other dimensions upon demand

Art.-Nr.	A	B	C	Z	NL/ph
718 216 303	216	3,0	30	60	
718 250 300	250	3,2	30	60	
718 250 301	250	3,2	30	80	
718 250 307	250	3,2	30	120	
718 250 320	250	3,2	32	60	
718 250 321	250	3,2	32	80	
718 250 322	250	3,2	32	96	
718 250 401	250	3,2	40	80	4/12/64 + 2/9/55
718 260 300	260	2,4	30	68	
718 275 301	275	3,2	30	88	
718 275 400	275	3,2	40	88	4/12/64 + 2/9/55
718 280 320	280	3,2	32	96	
718 300 300	300	3,2	30	72	
718 300 301	300	3,2	30	96	
718 300 302	300	3,2	30	120	
718 300 320	300	3,2	32	72	
718 300 321	300	3,2	32	96	
718 300 324	300	3,2	32	120	
718 300 400	300	3,2	40	72	
718 300 401	300	3,2	40	96	
718 330 302	330	3,2	30	96	
718 330 322	330	3,2	32	96	
718 350 300	350	3,3	30	84	
718 350 301	350	3,4	30	108	
718 350 321	350	3,3	32	84	
718 350 320	350	3,4	32	108	
718 350 400	350	3,3	40	84	4/12/64 + 2/9/55
718 350 401	350	3,4	40	108	4/12/64 + 2/9/55
718 350 501	350	3,3	50	84	4/12/64 + 4/15/80
718 350 500	350	3,4	50	108	4/12/64 + 4/15/80
718 380 320	380	3,8	32	110	
718 380 322	380	3,8	32	84	
718 400 302	400	3,8	30	66	
718 400 300	400	3,8	30	96	
718 400 304	400	3,6	30	120	
718 400 320	400	3,8	32	96	2/11/63
718 400 321	400	3,6	32	120	
718 400 400	400	3,8	40	96	4/12/64 + 2/9/55
718 400 500	400	3,8	50	96	4/12/64 +4/15/80
718 420 300	420	4,0	30	96	
718 420 301	420	3,8	30	108	
718 420 304	420	4,0	30	108	
718 420 302	420	3,8	30	108	6/6,5/80

718 420 303	420	4,0	30	120	
718 420 400	420	3,8	40	96	
718 420 401	420	3,8	40	108	
718 450 303	450	4,0	30	72	
718 450 301	450	4,0	30	108	
718 450 320	450	3,8	32	96	
718 450 321	450	4,0	32	108	
718 500 301	500	4,4	30	100	
718 500 302	500	4,0	30	120	
718 500 300	500	4,4	30	120	
718 500 303	500	4,2	30	140	
718 500 320	500	4,4	32	120	
718 520 300	520	4,4	30	120	
718 520 500	520	4,4	50	120	
718 550 300	550	4,4	30	110	
718 550 301	550	4,4	30	128	1/11/30
718 550 302	550	4,4	30	132	1/10,5/60
718 550 320	550	4,4	32	128	2/11/63
718 550 802	550	4,0	80	160	6/9/100
718 600 300	600	4,6	30	140	
718 600 400	600	4,6	40	140	
718 600 800	600	5,0	80	128	6/8/100

Kreissägeblätter HM-bestückt -positiv-

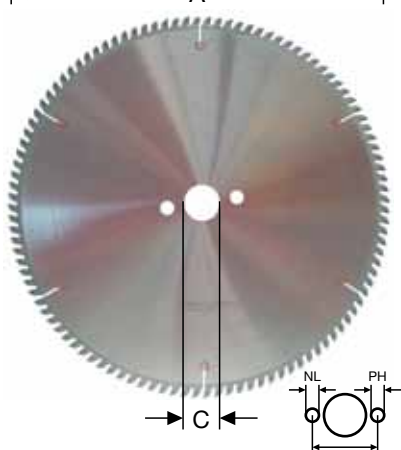
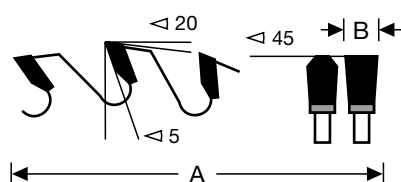

Flach-Trapez-Zahn, geräuschgedämpft,

- für Profile und Vollmaterial aus Aluminium, Kunststoff und NE-Metallen
- zum Einsatz auf Tischsägen, **Gehrungssägen (Sägeblatt von unten oder Vorschub von hinten)**

Weitere Abmessungen auf Anfrage

Carbide-tipped sawblades -positive rake-

TCG, noise reduced,

- for profiles of aluminium and plastics
- used on **table saws / mitre saws (sawblade feed from the bottom or from behind)**

Other dimensions upon demand

Art.-Nr.	A	B	C	Z	NL/ph
720 220 300	220	3,2	30	64	2/7/42
720 250 300	250	3,2	30	60	
720 250 301	250	3,2	30	80	
720 250 320	250	3,2	32	60	
720 250 321	250	3,2	32	80	
720 275 320	275	3,6	32	60	
720 275 400	275	3,2	40	72	4/12/64 + 2/9/55
720 280 322	280	3,2	32	88	
720 280 323	280	3,2	32	96	Combi
720 300 300	300	3,2	30	72	
720 300 301	300	3,2	30	96	
720 300 320	300	3,2	32	72	
720 300 321	300	3,2	32	96	
720 300 401	300	3,2	40	96	4/12/64 + 2/9/55
720 330 300	330	3,2	30	96	2/6,5/40
720 350 300	350	3,3	30	84	
720 350 301	350	3,4	30	108	
720 350 321	350	3,3	32	84	2/12/64
720 350 320	350	3,4	32	96	2/12/64
720 350 322	350	3,4	32	108	2/12/64
720 350 400	350	3,3	40	84	4/12/64 + 2/9/55
720 350 401	350	3,4	40	108	4/12/64 + 2/9/55
720 370 300	370	3,4	30	96	
720 380 321	380	3,8	32	56	
720 400 302	400	4,0	30	72	
720 400 300	400	3,8	30	96	
720 400 301	400	3,8	30	120	
720 400 320	400	3,8	32	96	2/12/64
720 400 400	400	3,8	40	96	4/12/64 +2/12/80
720 420 301	420	4,0	30	52	
720 400 323	400	3,6	32	120	
720 420 300	420	4,0	30	96	
720 420 303	420	4,0	30	120	
720 450 300	450	4,0	30	108	
720 450 321	450	3,8	32	96	2/12/64
720 450 320	450	4,0	32	108	2/12/64
720 500 306	500	4,2	30	72	
720 500 310	500	4,4	30	96	
720 500 302	500	4,0	30	120	1/10,5/30
720 500 305	500	4,0	30	120	2/10,5/70
720 500 300	500	4,4	30	120	2/11/70
720 500 309	500	4,0	30	160	2/12/64

720 500 321	500	4,0	32	100	2/12/64
720 500 320	500	4,0	32	120	2/12/64
720 500 322	500	4,4	32	120	2/12/64
720 500 500	500	4,4	50	120	2/10,5/70
720 500 802	500	4,4	80	120	6/9/100
720 500 803	500	4,0	80	140	6/9/100
720 520 300	520	4,4	30	120	
720 530 300	530	4,2	30	128	
720 550 303	550	4,4	30	72	
720 550 300	550	4,4	30	110	
720 550 304	550	4,4	30	120	1/11/30
720 550 305	550	4,2	30	132	
720 550 301	550	4,4	30	132	2/10,5/70
720 550 302	550	4,4	30	132	1/10,5/70
720 550 324	550	4,0	32	126	2/11/63
720 550 321	550	4,4	32	132	2/12/64
720 550 400	550	4,4	40	110	
720 550 500	550	4,4	50	110	
720 550 800	550	4,4	80	128	6/6,5/100
720 550 802	550	4,0	80	160	6/9/100
720 600 300	600	4,6	30	140	
720 600 321	600	4,6	32	140	2/12/64
720 600 400	600	4,6	40	140	
720 600 401	600	4,6	40	140	2/13/80
720 600 500	600	4,6	50	140	2/10,5/70
720 600 800	600	5,0	80	120	6/8/100
720 650 403	650	4,4	40	132	2/18,5/60
720 700 500	700	6,0	50	180	

Sägeblätter „Made in Germany“ saws blades “Made in Germany”

**Eigene Stammblattherstellung auf
„Trumpf“-Laser**

*In-house production of steel-body
on “Trumpf”-Lasercutmachines*



**Sägenfertigung vom Stammblatt bis zur
fertigen Präzisionssäge**

*sawblades production on modern
machine plants*



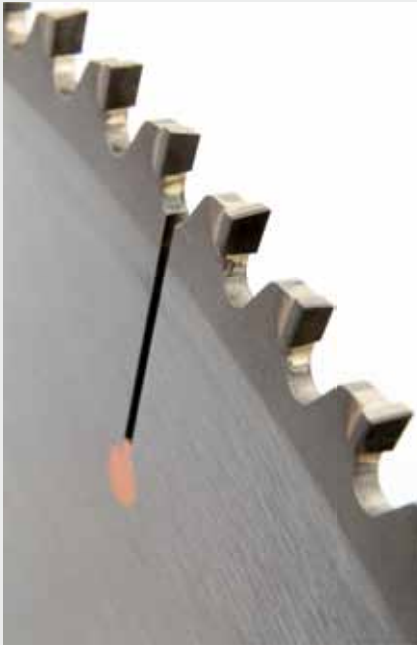

Spezial-Kreissägeblätter -Diamantbestückt-

92012

für den Zuschnitt von glasfaserverstärkten Profilen,
z.B. REHAU, aluplast, etc. – durch Axial-Winkel auch für co-extrudierte Dichtungen
Zahnform TF auch für Alu-Bearbeitung und massive GfK-Türschwellen

- bestmögliche Standzeit gegenüber High-tech-HM-Kreissägeblättern
- ideal für große Serien

Special sawblades -diamond-tipped-

for cut of fibreglass reinforced extrusions,
e.g. REHAU, aluplast, etc. – because of axial teeth angles also for co-extruded sealings
Tooth shape TF/TCG used for aluminium and solid FIBERLINE bottom rails etc.

- significant better life-time against high-tech carbide blades
- for big series

Art.-Nr.	A	B	C	Z	
728 420 301	420	3,4	30	100	TF / P
728 420 401	420	4,0	40	108	TF / N
728 500 300	500	3,5	30	120	GZ
728 500 301	500	3,4	30	120	TF / P
728 500 302	500	3,4	30	96	TF / P
728 500 303	500	3,5	30	140	GZ
728 500 800	500	3,5	80	120	GZ
728 500 801	500	3,5	80	140	GZ
728 550 300	550	3,8	30	132	GZ
728 600 800	600	5,0	80	120	GZ



Spezial-Kreissägeblätter -HM-bestückt-

92013

für den Zuschnitt von glasfaserverstärkten Profilen,
z.B. REHAU, aluplast, etc. – durch Axial-Winkel auch für co-extrudierte Dichtungen

- erheblich längere Standzeit gegenüber Standard-Kreissägeblättern
- ideal für kleine und mittlere Serien

Special sawblades -carbide-tipped-

for cut of fibreglass reinforced extrusions,
e.g. REHAU, aluplast, etc. – because of axial teeth angles also for co-extruded sealings

- significant better life-time against standard blades
- for small and medium series

Art.-Nr.	A	B	C	Z	
723 380 320	380	3,6	32	110	
723 420 300	420	3,6	30	100	
723 500 300	500	3,6	30	140	
723 500 320	500	3,6	32	140	
723 500 800	500	3,6	80	140	
723 550 300	550	4,0	30	160	
723 550 320	550	4,0	32	160	
723 550 800	550	4,0	80	160	

Metallkreissägeblätter HSS

92020

DM05 dampfbehandelt

für Stahlbearbeitung

Weitere Abmessungen auf Anfrage !

Metal cutting sawblades HSS

DM05 vaporized

for steel cutting

Other dimensions upon demand !

Art.-Nr.	A	B	C	Z	
702 200 321	200	1,8	32	128	
702 225 320	225	2,0	32	180	
702 250 324	250	2,0	32	160	
702 250 321	250	2,0	32	200	
702 250 322	250	2,0	32	240	
702 275 321	275	2,0	32	220	
702 275 320	275	2,5	32	220	
702 275 400	275	2,5	40	72	
702 275 405	275	2,5	40	110	
702 275 401	275	2,5	40	120	
702 275 404	275	2,5	40	140	
702 275 402	275	2,5	40	160	
702 275 403	275	2,5	40	220	
702 300 320	300	2,5	32	160	
702 300 321	300	2,5	32	220	
702 300 400	300	2,5	40	220	
702 350 321	350	2,5	32	180	
702 350 320	350	2,5	32	280	
702 400 500	400	3,5	50	80	
702 450 400	450	4,0	40	120	
702 450 401	450	3,0	40	350	
702 275 329	250	2,5	32	220	HSSE/Cobalt*
702 315 320	315	2,5	32	220	HSSE/Cobalt*
702 350 322	350	2,5	32	280	HSSE/Cobalt*
702 350 323	350	2,5	32	350	HSSE/Cobalt*

* Kobalt für Edelstahl / Cobalt for stainless steel



Metallkreissägeblätter

92021

für Isolierglasfertigung

Metal cutting sawblades

for spacer bars

Art.-Nr.	A	B	C	Z	
702 160 320	160	1,0	32	160	HSS
770 160 320	160	1,6	32	160	VHM / TC
702 200 325	200	1,0	32	200	HSS
702 200 326	200	1,0	32,	350	HSS
702 200 329	200	1,0 / 0,5	32	350	HSS



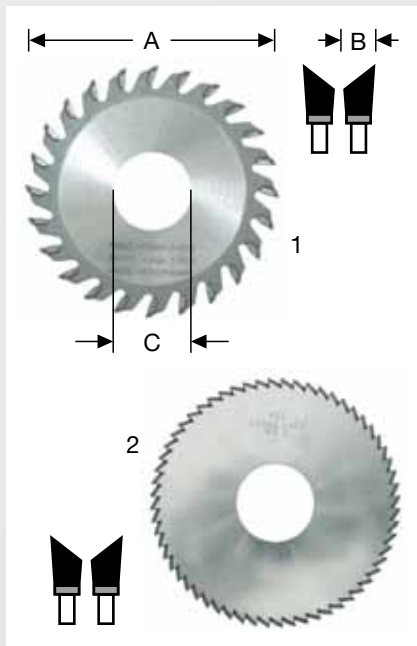
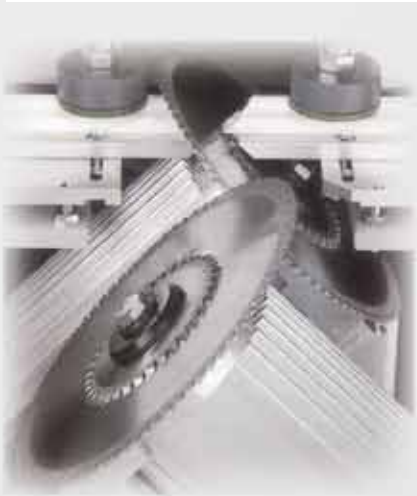
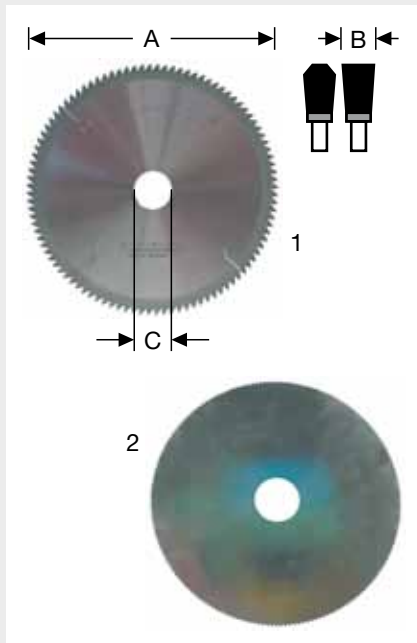

Glasleisten-Sägeblätter

92030

für elumatec, Haffner, Rotox, Striffler, Wegoma, etc.
1 = HM-bestückt - 2 = HSS Spezial

Glazing bead saw

for elumatec, Haffner, Rotox, Striffler, Wegoma, etc.
1 = carbide-tipped - 2 = HSS special

Art.-Nr.	A	B	C	Z	
720 138 200	138	2,5	20	42	1
704 150 202	150	2,6	20	48	1
720 160 200	160	2,5	20	48	1
720 175 200	175	2,1	20	68	1 W/AT
702 180 320	180	2,0	32	180	2
720 200 201	200	2,1	20	60	1 W/AT
718 200 300	200	2,8	30	54	1 W/AT
718 200 301	200	2,2	30	100	1
720 200 320	200	2,5	32	80	1
718 200 321	200	2,2	32	100	1
702 200 320	200	2,0	32	180	2
718 210 320	210	2,8	32	100	1
718 225 320	225	2,0	32	100	1
702 225 321	225	2,0	32	200	2
718 250 200	250	2,2	20	120	1
718 250 202	250	2,2	20	120	1 W/AT
702 250 200	250	2,0	20	180	2
702 250 325	250	2,0	32	180	2
718 275 300	275	3,2	30	88	1
720 300 302	300	2,4	30	96	1
720 300 305	300	3,2	30	120	1 W/AT
720 300 306	300	2,2	30	120	1

Glasleisten-Sägeblätter 45°

92031

passend zu 92030

1 = HM-bestückt - 2 = HSS Spezial
R = Rechts - L = Links

Glazing bead saw 45°

fits to 92030
1 = carbide tipped - 2 = HSS special
R = RH - L = LH

Art.-Nr.	A	B	C	Z	
718 092 300	92	3,0	30	24	1 R
718 092 301	92	3,0	30	24	1 L
720 095 200	95	2,1	20	20	1 R
720 095 201	95	2,1	20	20	1 L
702 098 320	98	2,0	32	60	2 R
702 098 321	98	2,0	32	60	2 L
720 098 320	98	3,0	32	36	1 R
720 098 321	98	3,0	32	36	1 L
720 103 320	103	2,1	32	24	1 R
720 103 321	103	2,1	32	24	1 L
702 103 320	103	2,1	32	60	2 R
702 103 321	103	2,1	32	60	2 L
720 150 300	150	4,0	30	32	1 R
720 150 301	150	4,0	30	32	1 L

für **Klinkschnitt-Sägen** und Bearbeitungszentren:
 elumatec, Graule, Pressta-Eisele, Rotox, Schüco, etc.

Carbide-tipped sawblades for endmilling machines

for **Vee-notching saws** and CNC-working centres:
 elumatec, Graule, Pressta Eisele, Rotox, Schüco, etc.

Art.-Nr.	A	B	C	Z		für Halter / for holders
700 180 200	180	3,5	20	34	1	elumatec (A)
700 180 320	180	3,2	32	28	3	
720 254 320	254	3,4	32	68	1	
720 254 321	254	3,4	32	80	1	
720 254 322	254	3,4	32	100	1	
720 300 322	300	3,4	32	104	1	
700 340 320	340	3,6	32	96	2	Emmegi (A)
700 350 401	350	3,4	40	96	2	
700 350 402	350	3,5	40	108	2	
700 380 400	380	3,8	40	110	1	
700 400 320	400	4,6	32	96	1	elumatec (A)
700 400 401	400	3,8	40	96	2	
700 400 500	400	3,8	50	96	2	
700 450 402	450	4,0	40	108	2	
700 500 300	500	4,4	30	120	1	
700 500 320	500	4,6	32	120	1	elumatec (A)
700 500 321	500	4,6	32	60	1	elumatec (A)
700 500 325	500	4,5	32	120	1	Emmegi (A)
700 500 500	500	4,4	50	120	1	
700 500 501	500	4,4	50	120	2	
700 550 400	550	4,4	40	110	1	
700 550 401	550	4,4	40	120	1	
700 550 500	550	4,4	50	110	1	
700 550 501	550	4,4	50	132	2	
700 550 502	550	4,4	50	132	2	
700 600 400	600	4,6	40	140	1	
700 650 400	650	5,0	40	140	3	
700 650 500	650	4,4	50	144	2	

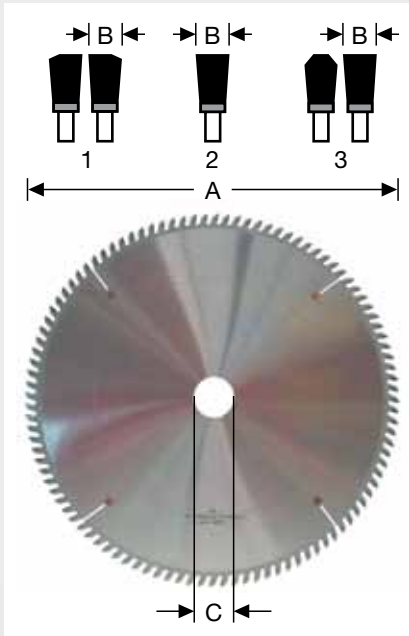

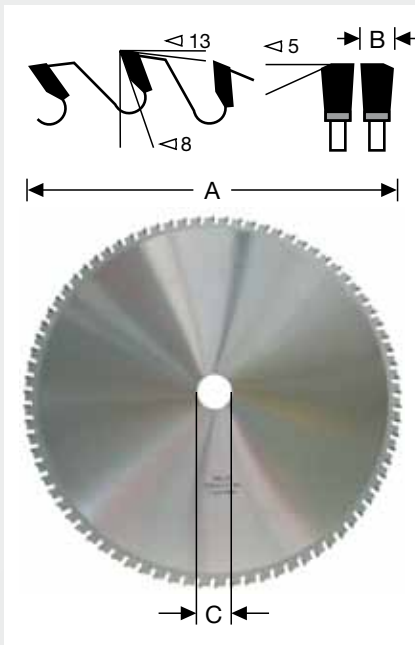

Stahl-Kreissägeblätter HM-bestückt

92041

für Trockenschnitt, Spezialzahn zum Trennen von Weichstahl, Metallverkleidungen, Flach- und Winkelisen, Rohre, Kabelkanäle, Bleche, Messing, Kupfer, Aluminium etc.

Carbide-tipped steel-circular sawblades

for dry-cutting, special teeth for cutting mild-steel, metal-clad workpieces, sandwich panels, angle irons, pipes, cable ducts, sheet metal, brass, copper, aluminium, etc.

Art.-Nr.	A	B	C	Z
707 160 200	160	2,2	20	30
707 190 301	190	2,4	30	38
707 190 302	190	2,2	30	48
707 200 300	200	2,4	30	40
707 210 302	210	2,4	30	40
707 216 300	216	2,4	30	40
707 230 301	230	2,4	30	44
707 250 301	250	2,4	30	48
707 300 300	300	2,4	30	60
707 300 301	300	2,4	30	80
707 305 257	305	2,4	25,4	60
707 305 254	305	2,4	25,4	80
707 350 255	350	2,4	25,4	72
707 350 300	350	2,6	30	80
707 355 256	355	2,6	25,4	80
707 355 301	355	2,4	30	90
707 400 300	400	3,0	30	84

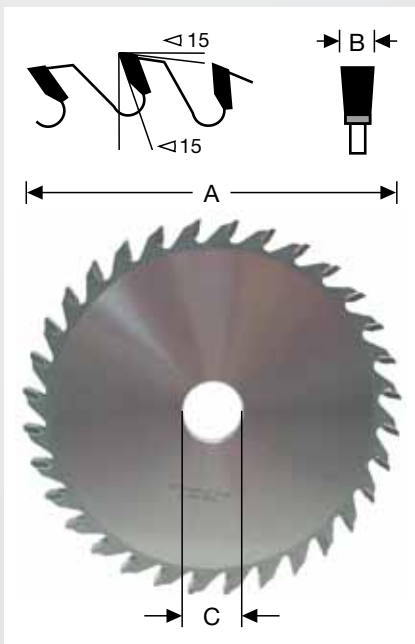

Auslinkfräser -Hartmetallbestückt-

92050

einsetzbar in Maschinen von:
elumatec, Graule, Haffner, Pressta-Eisele, Rotox, Schüco, Wegoma, etc.

Carbide-tipped endmilling cutters

for endmilling machines:
elumatec, Graule, Haffner, Pressta-Eisele, Rotox, Schüco, Wegoma, etc.

Art.-Nr.	A	B	C	Z
700 125 300	125	8,0	30	12
700 150 224	150	8,0	22	12
700 150 300	150	8,0	30	12
700 150 321	150	8,0	32	12
700 200 402	200	6,5	40	32
700 200 403	200	8,0	40	32
700 250 406	250	8,0	40	40
700 250 403	250	10,0	40	32
700 250 404	250	16,0	40	32
700 250 410	250	16,5	40	32
700 250 405	250	20,0	40	32
700 280 400	280	4,0	40	36
700 280 403	280	6,0	40	36
700 280 401	280	8,0	40	36
700 300 400	300	8,0	40	36

Säbelsägeblätter

92051

Spezial-Säbelsägeblätter für die Fensterdemontage*

Zähne gefräst und geschränkt, **Blatt aus Bi-Metall** für schnelle und gerade Schnitte **in allen Holzarten und Kunststoff**.

- lange Lebensdauer - **Bi-Metall** - VE: 10 Stk.

A = Gesamtlänge B = verzahnte Länge

Reciprocating sawblades

Special blades for dismantling of window-frames*

Teeth milled and side set, **bi-metal blade** for fast and straight cuts **in all types of wood and plastics**

- Long Lifetime - **Bi-Metal** - Packaging: 10 pcs.

A = total length B = cutting length

Art.-Nr.	A	B	
750 321 150	150	130	150 x 19 x 1,27 mm; 6 ZpZ (tpi)
750 321 225	225	205	225 x 19 x 1,27 mm; 6 ZpZ (tpi)

LONG LIFE

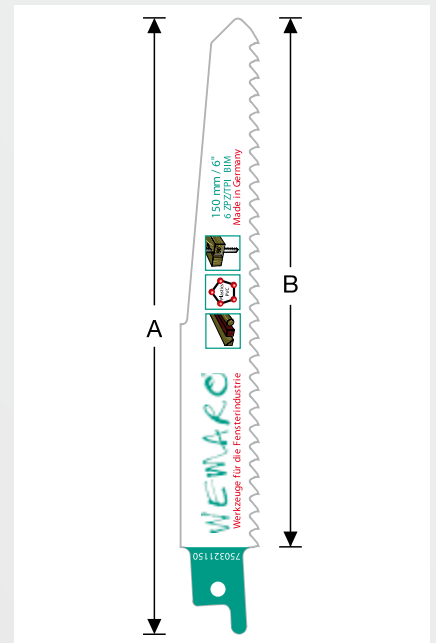

Säbelsägeblätter

92052

Spezial-Säbelsägeblätter für die Fensterdemontage*

Zähne gefräst und geschränkt, **variable Verzahnung**, **Blatt aus Bi-Metall** für schnelle und gerade Schnitte **in allen Holzarten mit Metallrückständen, Stahl > 3 mm**

- lange Lebensdauer - **Bi-Metall** - universell einsetzbar - VE: 10 Stk.

A = Gesamtlänge B = verzahnte Länge

Reciprocating sawblades

Special blades for dismantling of window-frames*

teeth milled and side set, **variable toothing**, **bi-metal blade** for fast and straight cuts **in all types of wood with metal residues, steel > 3 mm**

- Long Lifetime - **Bi-Metall** - Packaging: 10 pcs.

A = total length B = cutting length

Art.-Nr.	A	B	
750 810 150	150	130	150 x 19 x 1,27 mm; 8/10 ZpZ (tpi)
750 810 200	200	180	200 x 19 x 1,27 mm; 8/10 ZpZ (tpi)

LONG LIFE

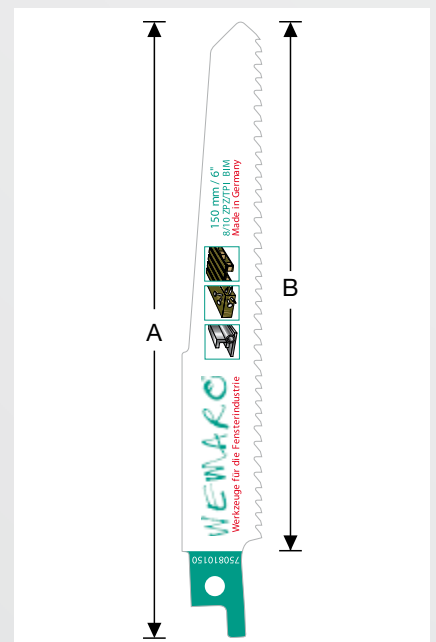

Säbelsägeblätter

92053

Spezial-Säbelsägeblätter für die Fensterdemontage*

Zähne gefräst und geschränkt, **variable Verzahnung**, **Blatt aus Bi-Metall** für **aggressive und gerade Schnitte in allen Holzarten mit Metallrückständen (> 80 mm)**

- lange Lebensdauer - **Bi-Metall** - universell einsetzbar - VE: 10 Stk.

A = Gesamtlänge B = verzahnte Länge

Reciprocating sawblades

Special blades for dismantling of window-frames*

teeth milled and side set, **variable toothing**, **Bi-Metal blade** for **aggressive and straight cuts in all types of wood with metal residues (> 80 mm)**

- Long Lifetime - **Bi-Metall** - Packaging: 10 pcs.

A = total length B = cutting length

Art.-Nr.	A	B	
750 058 150	150	130	150 x 19 x 1,27 mm; 5/8 ZpZ (tpi)
750 058 225	225	205	225 x 19 x 1,27 mm; 5/8 ZpZ (tpi)

LONG LIFE

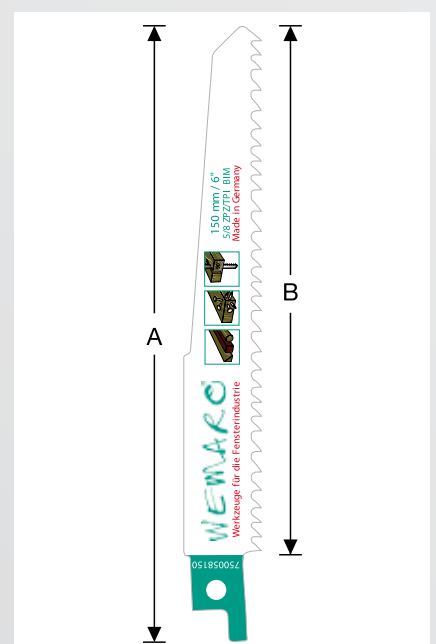

*passend zu / suitable for:

AEG, Atlas Copco, Black & Decker, Bosch, Elu, Fein, Flex, Hitachi, Metabo, Milwaukee, Porter Cable, Rems, Rockwell, Roller, Skil

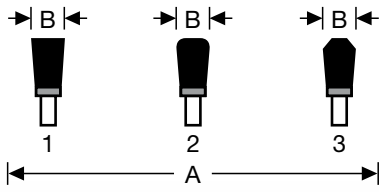

zum Bearbeiten der Aussenkontur auf CNC-Verputzmaschinen wie elumatec, Rotox, Stürtz, Urban, Wegoma, etc.

Carbide-tipped sawblades

Disk cutter for machining outer profile corners used on CNC-corner cleaners as elumatec, Rotox, Stürtz, Urban, Wegoma, etc.

Art.-Nr.	A	B	C	Z	Bild
700 152 300	152	3,5	30	48	3
473 817 450	170	4,5	20	12+4 R	2
473 817 460	170	4,5	20	12+4 L	2
700 180 250	180	2,8	25	48	1
473 819 450	190	4,5	20	16+4 R	2
473 819 460	190	4,5	20	16+4 L	2
700 200 300	200	3,0	30	48	1
700 225 300	225	3,6	30	54	3
700 230 200	230	4,5	20	54+6	2
700 230 328	230	3,0	30	60	2
700 230 300	230	3,0	30	60	1
700 250 200	250	4,5	20	56+8	2
700 250 201	250	4,5	20	68+5	2
700 250 329	250	3,3	30	54	1
700 250 327	250	2,5	32	54	1
700 250 328	250	3,3	32	54	1
700 250 326	250	5,0	32	32	2
700 250 325	250	5,0	32	32	2
700 250 324	250	5,0	32	63+5	2
700 250 399	250	5,0	30	8+12+12	2
700 300 200	300	4,0	25	90+6	1



Scheibenfräser – auch mit Radiuszähnen – für modernste Verputzautomaten

Corner cleaning blades – also with radius – for streamlined CNC-corner cleaning machines

- Präzisionsausführung, gerändelt
 Viele weitere Abmessungen verfügbar !

Bush for sawblades

precise version, rim
Many other sizes available !

Art.-Nr.	A	B	C
000 200 140	20	14	1,8
000 300 200	30	20	1,8
000 300 250	30	25	2,0
000 300 270	30	27	2,0
000 300 580	30	15,88	1,4
000 320 201	32	20	2,0
000 320 250	32	25	2,0
000 320 254	32	25,4	2,0
000 320 302	32	30	1,3
000 320 303	32	30	1,6
000 320 300	32	30	2,0
000 320 304	32	30	2,5
000 320 305	32	30	3,0
000 320 580	32	15,88	2,0
000 400 220	40	22	2,8
000 400 253	40	25	2,5
000 400 300	40	30	2,0
000 400 302	40	30	2,5
000 400 301	40	30	3,0
000 400 320	40	32	2,0
000 500 300	50	30	2,5
000 500 401	50	40	2,5

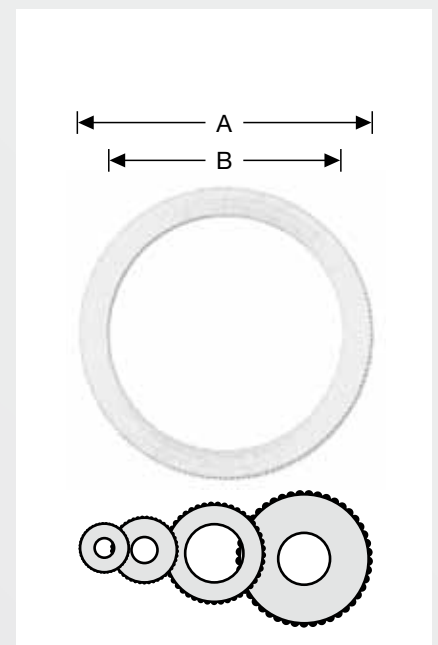



Kühlmittelkonzentrat

93000

- **biologisch abbaubar, wassermischbar** -
- Mischungsverhältnis: 1:20
- verwendbar für Aluminium und Stahl:
Kopierfräsmaschinen, Wasserschlitzfräsmaschinen, NE-Sägemaschinen, etc.

Coolant concentrate

- **free from environment polluting substances, water mix**
- *mixing proportion: 1:20*
- *used for aluminium and steel:*
copy-router machines, waterslot machines, sawing machines for aluminium, etc.

Art.-Nr.

600 000 005	5	Liter	Kanister	canister
600 000 020	20	Liter	Kanister	canister
600 000 200	200	Liter	Fass	drum



Kühlmittelkonzentrat

93001

- für Stahlbearbeitung
- Mischungsverhältnis 1:10
- verwendbar in:
Sägemaschinen / Umlaufkühlung für Stahlbearbeitung

Coolant concentrate

- *for steel working*
- *mixing proportion 1:10*
- *used in:*
steel sawing machines

Art.-Nr.

601 000 005	5	Liter	Kanister	canister
601 000 020	20	Liter	Kanister	canister



Hochleistungs-Kühlschmiermittel

93010

- verwendbar in:
Impuls-Sprüheinrichtungen (z.B. elumatec, Pressta-Eisele, Emmegi, etc.)

High-duty coolant liquid

- *used in:*
cycle mist spray units (e.g. elumatec, Pressta-Eisele, Emmegi, etc.)

Art.-Nr.

604 000 001	1	Liter	Flasche	bottle
604 000 005	5	Liter	Kanister	canister
604 000 020	20	Liter	Kanister	canister
604 000 200	200	Liter	Fass	drum

Hochleistungs-Kühlschmiermittel

93011

- reizarm
- verwendbar in:
Impuls-Sprüheinrichtungen (z.B. elumatec, Pressta-Eisele, Emmegi, etc.)

High-duty coolant liquid

- **no skin irritation**
- used in:
cycle mist spray units (e.g. elumatec, Pressta-Eisele, Emmegi, etc.)

Art.-Nr.

604 001 001	1	Liter	Flasche	bottle
604 001 005	5	Liter	Kanister	canister
604 001 020	20	Liter	Kanister	canister



Kühlschmiermittel RAPID

93015

universell verwendbar
geruchsneutral und verdampfungsarm

Coolant liquid RAPID

*All-purpose
odour neutral and low-volatility*

Art.-Nr.

606 000 005	5	Liter	Kanister	canister
606 000 020	20	Liter	Kanister	canister



Kühlschmiermittel EMMEGI P68

93016

- speziell abgestimmt auf EMMEGI-Maschinen wie z.B. QUADRA, SATELLITE, etc.

Coolant liquid EMMEGI P68

- special designed for pulsed spray coolant system EMMEGI QUADRA, SATELLITE, etc.

Art.-Nr.

607 000 005	5	Liter	Kanister	canister
607 000 020	20	Liter	Kanister	canister
607 000 200	200	Liter	Fass	drum





Hochleistungs-Kühlschmiermittel

93017

- sehr dünnflüssig und schnell verdunstend
- rückstandsfrei
- verwendbar in:
Impuls-Sprüheinrichtungen (z.B. elumatec, Pressta-Eisele, Emmegi, etc.)

High-duty coolant liquid

- *with low viscosity and fast exhale*
- *residue-free*
- *used in:*
cycle mist spray units (e.g. elumatec, Pressta-Eisele, Emmegi, etc.)

Art.-Nr.

608 000 005	5	Liter	Kanister	canister
608 000 020	20	Liter	Kanister	canister



Kühlschmierstift

93020

- für Maschinen ohne Sprüheinrichtung
- zum Kühlen und Schmieren von Sägeblätter, Fräsern, Bohrern, Gewindewerkzeugen.

Lubricant stick

- *for machines without spray unit*
- *to cool and lubricate circular sawblades, cutters, drills and thread toolings.*

Art.-Nr.

602 000 350	300 g
-------------	-------



Schneidöl-EP-Spray

93021

Hochleistungsschneidöl mit EP-Zusätzen

- **verschleißmindernd und außerordentliche Schmierfilmfestigkeit**
- chlor- silikon- und wachsfrei

Cutting oil spray

High-duty cutting oil with EP (Extreme-Pressure) additives

- **abrasive wear and best possible lubricating oil film**
- free of chlorine-silicon-wax*

Art.-Nr.

602 000 400	400 ml
-------------	--------

Einkomponentenkleber ALU RAPID P860

93100

zur **einfachen, sparsamen und festen Verklebung von Alu-Profilen** in Fenster-, Türen-, und Fahrzeugbau.
Gepüft vom „Fensterinstitut Rosenheim“ -
Detaillierte Unterlagen und Datenblatt erhalten Sie auf Anfrage.
A = Menge
B = 1 - Kartusche, 2 - Schlauchbeutel
C = Verpackungseinheit
Farbe Schwarz auf Anfrage

One-component adhesive ALU RAPID P860

for **simple, economical and strong cementing of aluminium-profiles** in window-, door- and vehicle constructions.
Proofed by „Fensterinstitut Rosenheim“ -
Detailed informations and technical data sheet available upon request.
A = Quantity
B = 1 - cartridges, 2 - tubes
C = packaging / box
colour black on request

Art.-Nr.	A	B	C	D
980 013 105	310 ml	1	20	weiss / white
980 013 107	580 ml	2	20	weiss / white auf Anfrage / upon request



Klebegeräte

93101

passend zu 93100.
Zur Verarbeitung unseres Einkomponentenklebers P860
A = für Kartuschengröße - B = Anwendung

Glue equipment

suitable for 93100.
To handle our glue P860

A = fits to cartridge - B = use

Art.-Nr.	A	B	Bild
980 013 201	310 ml	man.	1
980 013 202	310 ml	pneum.	2
980 013 200	580 ml	man.	1
980 013 203	580 ml	pneum.	3



Eckwinkel kleben mit EINKOMPONENTEN-KLEBER
– die fortschrittlichste und sparsamste Methode

Fix your corner with ONE-COMPONENT GLUE
– the most economic method





Spezialreiniger ALU CLEANER P860

93102

- auf biologischer Basis
- für lackierte, eloxierte und pulverbeschichtete Aluminiumprofile

Special cleaning liquid ALU CLEANER P860

- on base of biological rawmaterials
- for painted, anodised and powder-coated aluminium profiles

Art.-Nr.

603 000 001	1	Liter	Dose	can
603 000 010	10	Liter	Kanister	canister
603 000 030	30	Liter	Kanister	canister
603 000 200	200	Liter	Fass	drum



Kleber für Dichtungsprofile

93200

Stoßfugen und Gehrungsschnitte an Fensterdichtungen schnell, sicher und dauerhaft verkleben. VE = 10 Flaschen

Special glue for sealings

to glue window seals at the cut surface. Box = 10 bottles

Art.-Nr.

A

900 000 631	20 g
900 000 632	50 g

Spannzangen

94000

passend zu:

Elu MOF 77, 131, 177

ROTOX KF - Serie 1

elumatec Bohreinheiten

elumatec AS 170 / GF 171 / KF178 / SBZ 122

Collets

suitable to

Elu MOF 77, 131, 177

ROTOX KF - Serie 1

elumatec drill units

elumatec AS 170 / GF 171 / KF178 / SBZ 122

Art.-Nr.	A	B	C
077 351 030	3,0	19,6	34,2
077 351 040	4,0	19,6	34,2
077 351 050	5,0	19,6	34,2
077 351 060	6,0	19,6	34,2
077 351 063	6,35	19,6	34,2
077 351 070	7,0	19,6	34,2
077 351 080	8,0	19,6	34,2
077 351 090	9,0	19,6	34,2
077 351 095	9,52	19,6	34,2
077 351 100	10,0	19,6	34,2
077 351 120	12,0	19,6	34,2
077 351 127	12,7	19,6	34,2



Spannzangen

94001

passend zu:

Elu MOF 96

Wegoma OF

Perles OF

ROTOX Wasserschlitzfräsen

Collets

suitable to:

Elu MOF 96

Wegoma OF

Perles OF

ROTOX Water slot machines

Art.-Nr.	A	B	C
053 351 005	6,0	13,5	26,0
053 351 006	6,35	13,5	26,0
053 351 004	8,0	13,5	26,0



Spannzangen

94002

passend zu:
elumatec AS70, KF78, Haffner

Collets

suitable to:
elumatec AS70, KF78, Haffner

Art.-Nr.	A	B	C			
070 351 000	8,0	70,2	M8			
900 000 171	8,0	69,0	M10	MK2	Haffner	MLA
078 351 000	10,0	70,2	M8			
900 000 172	10,0	69,0	M10	MK2	Haffner	MLA



Spannzangen

94003

passend zu:
Haffner, Wegoma KF

Collets

suitable to:
Haffner, Wegoma KF

Art.-Nr.	A	B	C			
900 000 016	5,0	16,9	33,0			
900 000 017	6,0	16,9	33,0			
900 000 095	6,35	16,9	33,0			
900 000 018	8,0	16,9	33,0			
900 000 019	10,0	16,9	33,0			



Spannzangen

94004

passend zu:
Pertici Kopierfräsen

Collets

suitable to:
Pertici copy routers

Art.-Nr.	A	B	C			
900 000 031	8,0	15	30,3			
900 000 033	10,0	15	30,3			



Spannzangen

94005

passend zu:
ROTOX KF ab Serie 2

Collets

suitable to:
ROTOX KF up from series 2

Art.-Nr.	A	B	C
900 000 021	6,0	15,6	34,5
900 000 022	8,0	15,6	34,5
900 000 023	10,0	15,6	34,5



Spannzangen

94006

passend zu:
elumatec SBZ 130 / 140 / 150, SKL 118, ALTECH, Emmegi, TEKNA

Collets

suitable to:
elumatec SBZ 130 / 140 / 150, SKL 118, ALTECH, Emmegi, TEKNA

Art.-Nr.	A	B	C
130 351 006	3,0-4,0	33,0	40,2
130 351 007	4,0-5,0	33,0	40,2
130 351 007	5,0-6,0	33,0	40,2
130 351 008	6,0-7,0	33,0	40,2
130 351 000	7,0-8,0	33,0	40,2
130 351 001	9,0-10,0	33,0	40,2
130 351 002	11,0-12,0	33,0	40,2
130 351 003	15,0-16,0	33,0	40,2
130 351 004	19,0-20,0	33,0	40,2



Spannzangen

94007

passend zu:
Pressta-Eisele KF, Emmegi, FOM, elumatec

Collets

suitable to:
Pressta-Eisele KF, Emmegi, FOM, elumatec

Art.-Nr.	A	B	C
900 000 073	6,0	21,0	31,5
900 000 074	8,0	21,0	31,5
900 000 075	10,0	21,0	31,5
900 000 170	12,0	21,0	31,5





Spannzangen

94008

passend zu: elumatec SBZ Type 122, EMMEGI, Pressta CopyS, Rotox AKF, Schüco

Collets

suitable to: elumatec SBZ Type 122, EMMEGI, Pressta CopyS, Rotox AKF, Schüco

Art.-Nr.	A	B	C
122 351 010	0,5-1,0	16,8	28
122 351 015	1,0-1,5	16,8	28
122 351 020	1,5-2,0	16,8	28
122 351 025	2,0-2,5	16,8	28
122 351 030	2,5-3,0	16,8	28
122 351 040	3,0-4,0	16,8	28
122 351 050	4,0-5,0	16,8	28
122 351 060	5,0-6,0	16,8	28
122 351 070	6,0-7,0	16,8	28
122 351 080	7,0-8,0	16,8	28
122 351 090	8,0-9,0	16,8	28
122 351 000	9,0-10,0	16,8	28

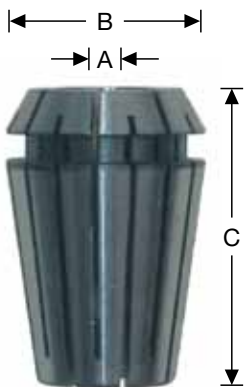

Spannzangen

94012

passend zu: elumatec BZ, EMMEGI, Thorwesten

Collets

suitable to: elumatec BZ, EMMEGI, Thorwesten

Art.-Nr.	A	B	C
900 000 504	3,0-4,0	25,7	34
900 000 506	5,0-6,0	25,7	34
900 000 508	7,0-8,0	25,7	34
900 000 509	8,0-9,0	25,7	34
900 000 510	9,0-10,0	25,7	34
900 000 511	10,0-11,0	25,7	34
900 000 512	11,0-12,0	25,7	34



Spannzangen

94014

passend zu: elumatec SBZ 610, Haffner
Weitere Abmessungen auf Anfrage

Collets

suitable to: elumatec SBZ 610, Haffner
Other dimensions upon demand

Art.-Nr.	A	B	C
610 351 003	5,0	19,8	33
610 351 004	6,0	19,8	33
610 351 001	8,0	19,8	33
610 351 000	10,0	19,8	33
610 351 012	12,0	19,8	33

Spannzangen

94015

passend zu: Mehrspindel-Bohrköpfen mit Anzugsgewinde M8x0,75 mm

Collets

suitable to: Multi-spindle drill heads with male thread M8x0,75 mm

Art.-Nr.	A	B	C
900 000 452	3,0	10,9	33
900 000 453	4,0	10,9	33
900 000 455	5,0	10,9	33
900 000 456	6,0	10,9	33

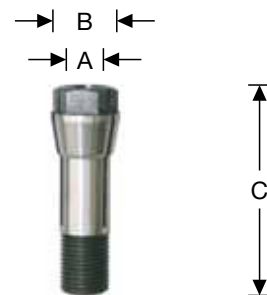

Spannzangen

94018

Typ ER 40

Collets

type ER 40

Art.-Nr.	A	B	C
900 000 750	3,0-4,0	41	46
900 000 752	5,0-6,0	41	46
900 000 754	7,0-8,0	41	46
900 000 755	8,0-9,0	41	46
900 000 756	9,0-10,0	41	46
900 000 758	11,0-12,0	41	46
900 000 759	12,0-13,0	41	46
900 000 763	16,0-17,0	41	46



Spannzangen

94019

Typ ER 50

Collets

type ER 50

Art.-Nr.	A	B	C
900 000 650	3,0-4,0	35	52
900 000 652	5,0-6,0	35	52
900 000 654	7,0-8,0	35	52
900 000 655	8,0-9,0	35	52
900 000 656	9,0-10,0	35	52
900 000 658	11,0-12,0	35	52
900 000 659	12,0-13,0	35	52
900 000 663	16,0-17,0	35	52





A = Bild - B = passend zu

Collet nut

A = picture - B = suitable to

Art.-Nr.	A	B	Spannschlüssel / wrench
053 107 400	1	94001	
077 107 400	2	94000	
112 122 402	2	94000	
122 107 400	3	94008	122 351 888
900 000 024	4	94005	
900 000 020	5	94003	
900 000 068	6	94004	
900 000 076	7	94007	900 000 888
900 352 100	7	94012	
130 352 100	8	94006	130 351 888

Präzisions-Spannzangenfutter

94016

für CNC Bearbeitungszentren wie Biesse, elumatec, Emmegi, FOM, Italmac, Mecal, SMC, etc.

C = passende Spannzangen zu

Precision collet chuck

suitable for CNC machining centres as Biesse, elumatec, Emmegi, FOM, Italmac, Mecal, SMC, etc.

C = suitable collets

Art.-Nr.	A	B	C	D
136 350 855	60	50	94006	HSK50F
136 350 813	63	25	94000	HSK63F
136 350 817	67	47	94006	HSK63F
136 350 850	70	43	94012	HSK63F
136 350 852	70	50	94006	HSK63F
136 350 853	76	60	94017	HSK63F
136 350 854	79	63	94018	HSK63F
136 350 818	98	25	94000	HSK63F
136 350 851	100	43	94012	HSK63F
136 350 852	100	63	94006	HSK63F
136 350 812	142	25	94000	HSK63F
136 350 856	80	22	94008	HSK40E
136 350 857	63	50	94006	SK40
136 350 858	50	50	94006	SK30
136 350 859	50	50	94006	ISO30
136 350 860	67	50	94006	ISO30



Präzisions-Bohrfutter

94017

für CNC Bearbeitungszentren wie Biesse, elumatec, Emmegi, FOM, Italmac, Mecal, SMC, etc.

Precision drill chuck

suitable for CNC machining centres as Biesse, elumatec, Emmegi, FOM, Italmac, Mecal, SMC, etc.

Art.-Nr.	A	B	C	D
136 350 801	97	57	3-16	HSK63F
136 350 800	111	45	1-10	HSK63F
130 350 800	90	50	1-13	SK30
130 350 803	90	50	1-13	SK40



Hand-Entgratmesser

95000

zur manuellen **Bearbeitung** von Schweißraupen an Kunststoff-Fenstern

Moon knife

used to remove welding sprue from UPVC-windows

Art.-Nr.			Bild
900 000 202		Economy	1
900 000 010	Original / Genuine	Don Carlos	2

Messerführung hierzu auf Anfrage

Button stick on request



Hand-Abstechmesser

95001

mit Handgriff, gebogen 110mm

Groove knife

with handle, 110 mm

Art.-Nr.

900 000 121

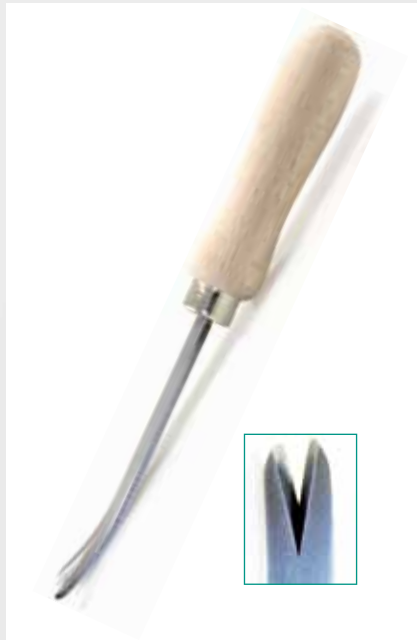

**Die preisgünstigste Möglichkeit zum Entfernen von Schweißraupen
– Hand-Entgrat- und Hand-Abstechmesser aus bestem Werkzeugstahl**

***The cheapest method to remove welding sprue
– Moon knives and Groove knives made of best steel quality***

Sichtflächenmesser

95002

zum Abstechen der Sichtflächenschweißraupe bei Kunststoff-Fenstern.

z.B. auf Maschinen von Actual, elumatec, KMW, Pertici, Rotox, Stürtz, Urban, Wegoma, Zierke, etc.

Weitere Sonderausführungen auf Anfrage lieferbar

Groove knives

for grooving top and bottom surfaces of welded UPVC-window corners.

Used on machines of Actual, elumatec, KMW, Pertici, Rotox, Stürtz, Urban, Wegoma, Zierke, etc.

Also special design for other machines on request

Art.-Nr.	A	B	C	D	P
900 000 040	19	35	0,0	0,0	1
900 000 041	19	35	2,5	0,3	1
900 000 050	19	35	2,5	0,4	1
900 000 042	19	35	2,5	0,5	1
900 000 213	19	35	2,8	0,5	1
900 000 044	19	35	3,0	0,3	1
900 000 039	19	35	3,0	0,5	1
900 000 143	19	35	3,5	0,5	1
900 000 144	19	35	5,0	-0,1	1
900 000 209	19	40	0,0	0,0	2
900 000 212	19	40	2,8	0,5	2
900 000 214	19	40	3,6	0,5	2
900 000 226	24	30	2,5	0,5	2
900 000 224	24	41	0,0	0,0	2
900 000 220	24	41	2,5	0,5	2
900 000 219	24	41	3,0	0,7	2
900 000 229	24	41	3,0	0,3	2
900 000 221	24	41	3,0	0,5	2
900 000 072	19	35	3,0	0,5	5
900 000 071	19	35	3,0	0,5	6
900 000 064	24	15	3,0	0,5	7
900 000 066	24	15	3,0	0,7	8
900 000 087	24	25	3,0	0,5	10
900 000 250	19	40	3,0	0,5	13
900 000 241	20	25	3,0	0,5	17
900 000 242	16	43	3,0	0,6	18
900 000 245	19	50	3,0	0,5	21
900 000 051	19	35	2,5	0,7	1
900 000 038	19	35	3,0	0,7	1
900 000 215	19	40	2,8	0,3	2
900 001 039	19	35	3,5	-0,1	1
900 007 042	19	35	V	V	1
900 007 212	19	40	V	V	2
900 007 221	24	41	V	V	1
900 007 245	19	50	V	V	21

Inneneckmesser

95003

Inside cleaning knives

Art.-Nr.	A	Abb.			
900 000 300	39	1	einfach	single-	hook
900 000 303	55	2	doppelt	double-	hook

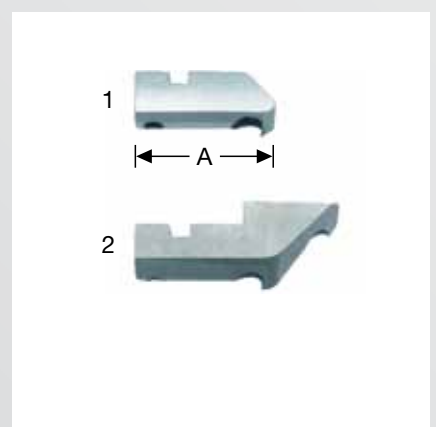
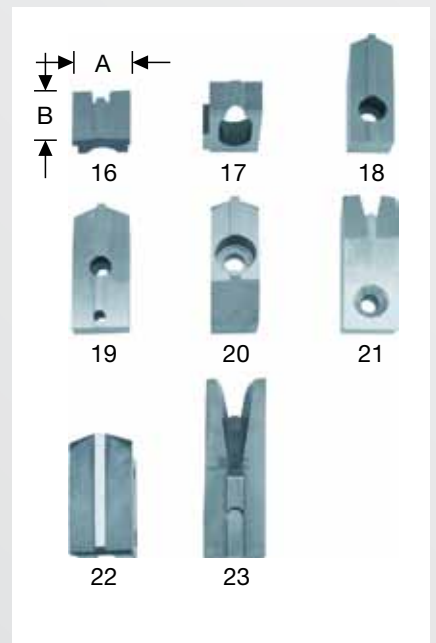
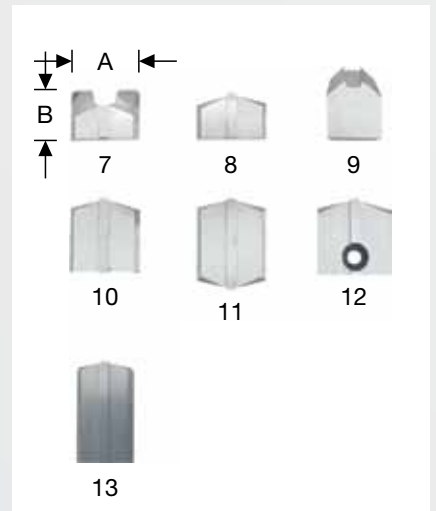
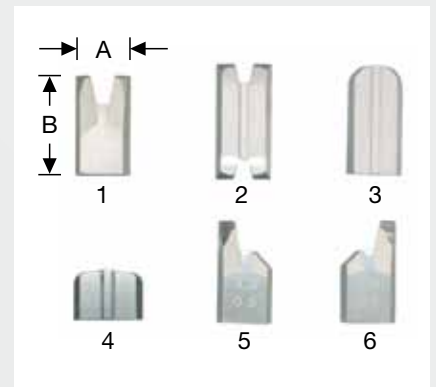

Auslink-Zange

95019

zum Ausklinken von Gummidichtungen an Glasfassaden-Bauelementen
rationeller Auslinkschnitt ohne Abmessen, ohne Verschnitt

Notching pliers

*for reasonable assembling of rubber gaskets on glass clading panels / curtain wall
extrusions without measuring, no waste*

Art.-Nr.	A	B
900 000 280	51	15
900 000 281	61	15



Gehrungsscheren

95020

sind überall dort unentbehrlich, wo Leisten, Profile, Kunststoff, Gummi oder Holz auf
Gehrung geschnitten werden sollen.

- zwei stehende Anschläge 45°
- alle Teile hochglanzverchromt mit PVC-Handgriff
- * dünne Klinge für kleine und sehr weiche Profile

Gasket shears

for industry and trade handicraft.

- to cut ledges, profiles etc. made of plastics, rubber or wood
- two fixed stops 45°
- * thin cutting blade for small or very soft extrusions

Art.-Nr.				Abb.
900 000 014	Standard	Economy		1
900 000 140	Original	Genuine	Löwe	1
900 000 002	Spezial	special	*	2

Ersatzteile / Spare Parts

Art.Nr.	Beschreibung / Description
900 100 014	Ersatzklinge Spare blade
900 100 140	Ersatzklinge Original Löwe Spare blade Löwe



Gehrungsscheren V-Schnitt

95021

für alle Dichtungsprofile an Fenstern.
Rationelle Dichtungsmontage ohne Abmessen, ohne Verschnitt

V-notch gasket shears

*for all kind of window- and door sealings.
Reasonable assembling of sealings without measuring, no waste*

Art.-Nr.

900 000 080 Original Löwe

Ersatzteile / Spare Parts

Art.Nr. Beschreibung / Description

900 000 081 Ersatzklingen (Paar)
Spare knife (pair)



Gehrungsschere -verstellbar-

95022

für alle Dichtungsprofile an Fenstern, Türen, etc. ;
Winkel 45°/60°/75°/90°/105°/120°/135° einstellbar

Gasket shears -adjustable-

*for all kind of window- and door sealings ;
adjustable angels 45°/60°/75°/90°/105°/120°/135°*

Art.-Nr.

900 000 013

Ersatzteile / Spare Parts

Art.Nr. Beschreibung / Description

900 100 014 Ersatzklinge
Spare blade





Dichtungsschere

95023

Universalschere, beste Qualität
dauerhaft, rostfrei, präzise und scharf

Gasket scissor

*All-round scissors, best quality
lasting, stainless, exact and sharp -Finny brand-*

Art.-Nr.

900 000 007

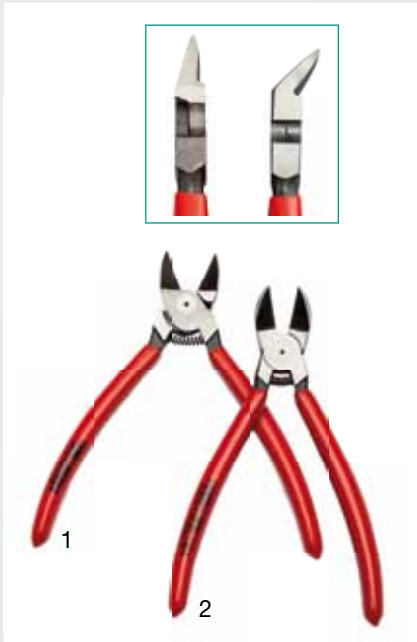

Seitenschneider für Kunststoff

95024

zum bündigen Abschneiden von Kunststoff
- gerade (1)
- 45° abgewinkelt für Inneneck-Arbeiten (2)

Side cutter for PVC

*for flush cut of PVC
- straight
- 45° angle, internal corner gasket snips*

Art.-Nr.

900 000 012 1

900 000 015 2

zum problemlosen, raschen Eindrücken der Dichtung.
 Rollendurchmesser 40 mm.

Gasket roller

for reasonable assembling of sealings.
 Diameter of roll 40 mm.

Art.-Nr.	Abb.
952 000 001	1
952 000 002	2
952 000 003	3
952 000 004	4
952 000 005	5
952 000 006	6
952 000 007	7
952 000 008	8
952 000 009	9
952 000 010	10
952 000 011	11

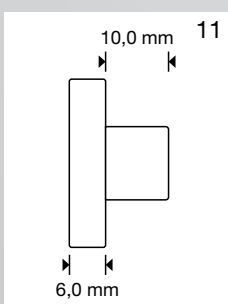
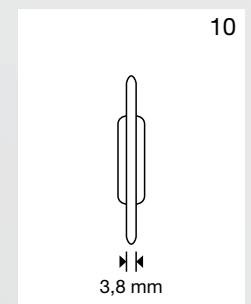
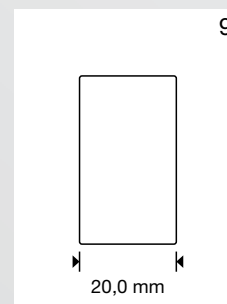
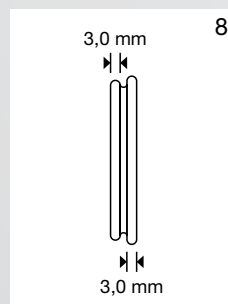
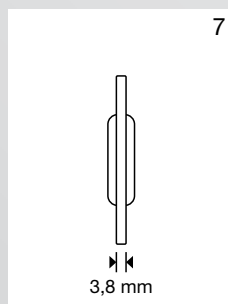
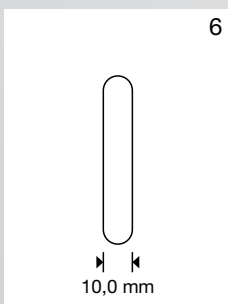
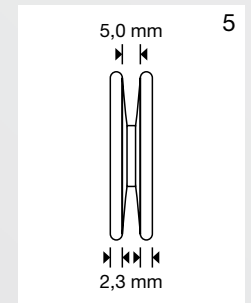
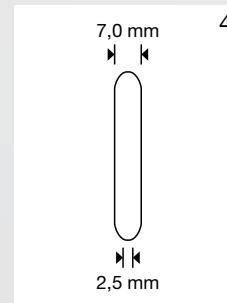
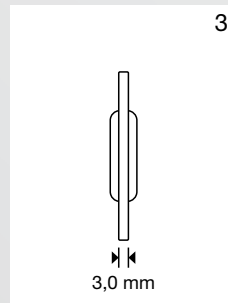
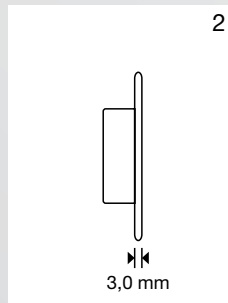
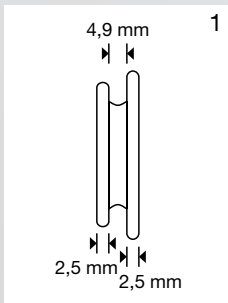

Schrauber Bits

95030

Insert bits

1/4" C 6.3

Art.-Nr.	A	L
900 000 077	PH1	25
900 000 026	PH2	25
900 000 025	PH2	50
900 000 115	PZ2	50
900 000 183	PH2	100
900 000 078	PH3	25
900 000 027	PZ2	25
900 000 086	TORX30	25
900 000 116	TORX10	50
900 000 117	TORX15	50
900 000 118	TORX20	50
900 000 119	TORX25	50
900 000 120	TORX30	50

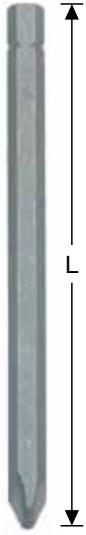

Schrauber Bits

95031

Insert bits

1/4" E 6.3

Art.-Nr.	A	L	
900 000 177	TORX30	50	
900 000 186	PH2	50	
900 000 187	PH2	100	
900 000 168	PH2	152	red.6,0 mm

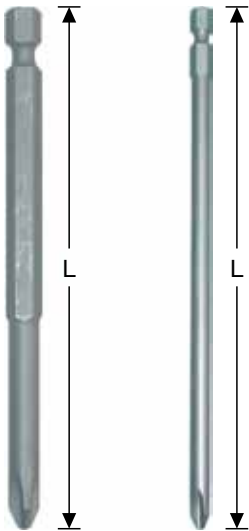

Schrauber Bits

95032

mit Gewinde.

für stationäre Schraubeinheiten Powasert, Rotox, Striffler, Stürtz, Urban, Wegoma, etc

Insert bits

with thread.

for stationary screw units Powasert, Rotox, Striffler, Stürtz, Urban, Wegoma, etc.

Art.-Nr.	A	B	L	
900 000 184	PH2	M4	33	
900 000 185	PH2	M5	33	
900 000 179	PH2	M5	33	d-7,0 mm
900 003 185	PH2	M5	33	d-6,0 mm
900 050 185	PH2	M5	33	ZrN-besch./ZrN-coated
900 000 079	PH2	M5	45	
900 000 029	PH2	M5	50	
900 000 034	PH2	UNF10-32	45	
900 000 030	PH2	M6	44	
900 000 028	PH2	M6	44	d-6,0 mm
900 015 079	TX15	M5	45	
900 020 079	TX20	M5	45	
900 050 034	PH2	UNF10-32	45	ZrN-besch./ZrN-coated
900 050 079	PH2	M5	45	ZrN-besch./ZrN-coated
900 050 179	PH2	M5	33	ZrN-besch./ZrN-coated

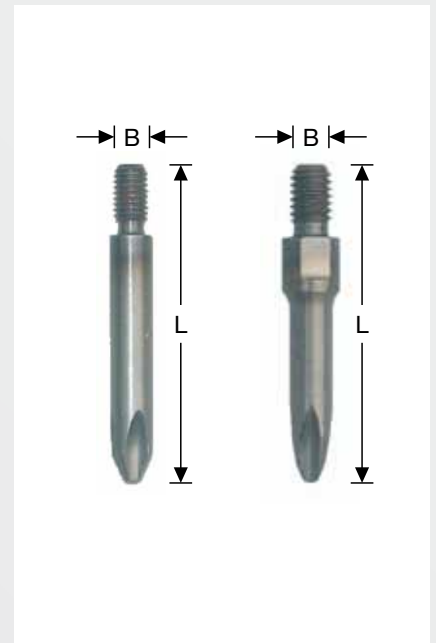

Schrauber Bits

95033

mit Gewinde.

Für stationäre Schraubeinheiten Powasert, Rotox, Striffler, Stürtz, Urban, Wegoma, etc.
abgeschrägte Flanken für bestmögliche Passform

Insert Bits

with thread.

For stationary screw units Powasert, Rotox, Striffler, Stürtz, Urban, Wegoma, etc.

with canted edges for perfect fit

Art.-Nr.	A	B	L
900 042 034	PH2	UNF10-32	45
900 042 179	PH2	M5	33

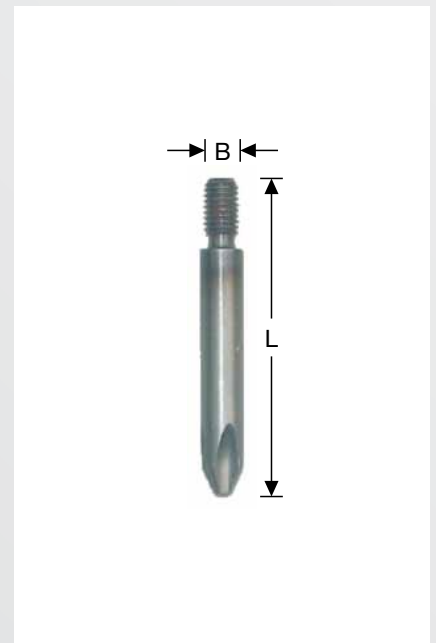

Bit-Verlängerung mit Gewinde M5

95036

passend für stationäre Schraubeinheiten
1/4" E 6.3

Bit extension for bits with male thread M5

suitable for stationary screw units
1/4" E 6.3

Art.-Nr.	L		
900 000 193	90	M5	
900 000 200	116	M5	
900 000 194	128	M5	
900 000 195	150	M5	
900 000 207	115	UNF10/32	elumatec
900 000 205	142	UNF10/32	
900 000 208	155	UNF10/32	elumatec
900 000 211	158	M5	
900 000 206	158	UNF10/32	
900 000 231	162	UNF10/32	

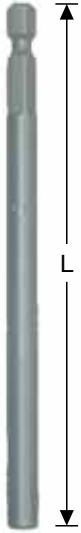

Zwischenstück

95037

mit beidseitigem Innengewinde

Connection

with female thread on both sides

Art.-Nr.	B	D	L		
900 000 191	M5	8	25		
900 001 191	M5	7,6	25		
900 000 192	M5/M6	8	30		
900 000 196	UNF10/32	8	27	IG/AG	male/female

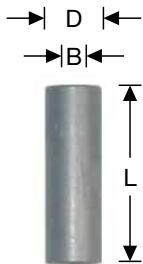

Bit-Verlängerung

95038

Spezialausführung POWASERT ADS, Stürzt, etc.

Bit extension

special for POWASERT ADS, Stürzt, etc.

Art.-Nr.	L mm			
900 000 198	175	UNF	Innen-Gewinde	female thread
900 000 201	175	M5	Innen-Gewinde	female thread
900 001 201	158	M5	Aussen-Gewinde	male thread

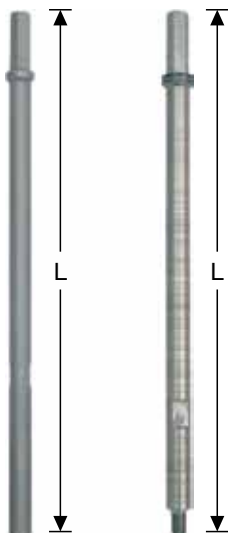

Bit-Verlängerung

95039

Spezialausführung
z.B. Federhenn, Schirmer, etc.

Bit-Extension

special version for Federhenn, Schirmer, etc.

Art.-Nr.	L		B
900 000 203	154	M5	1
900 000 204	141	M5	2

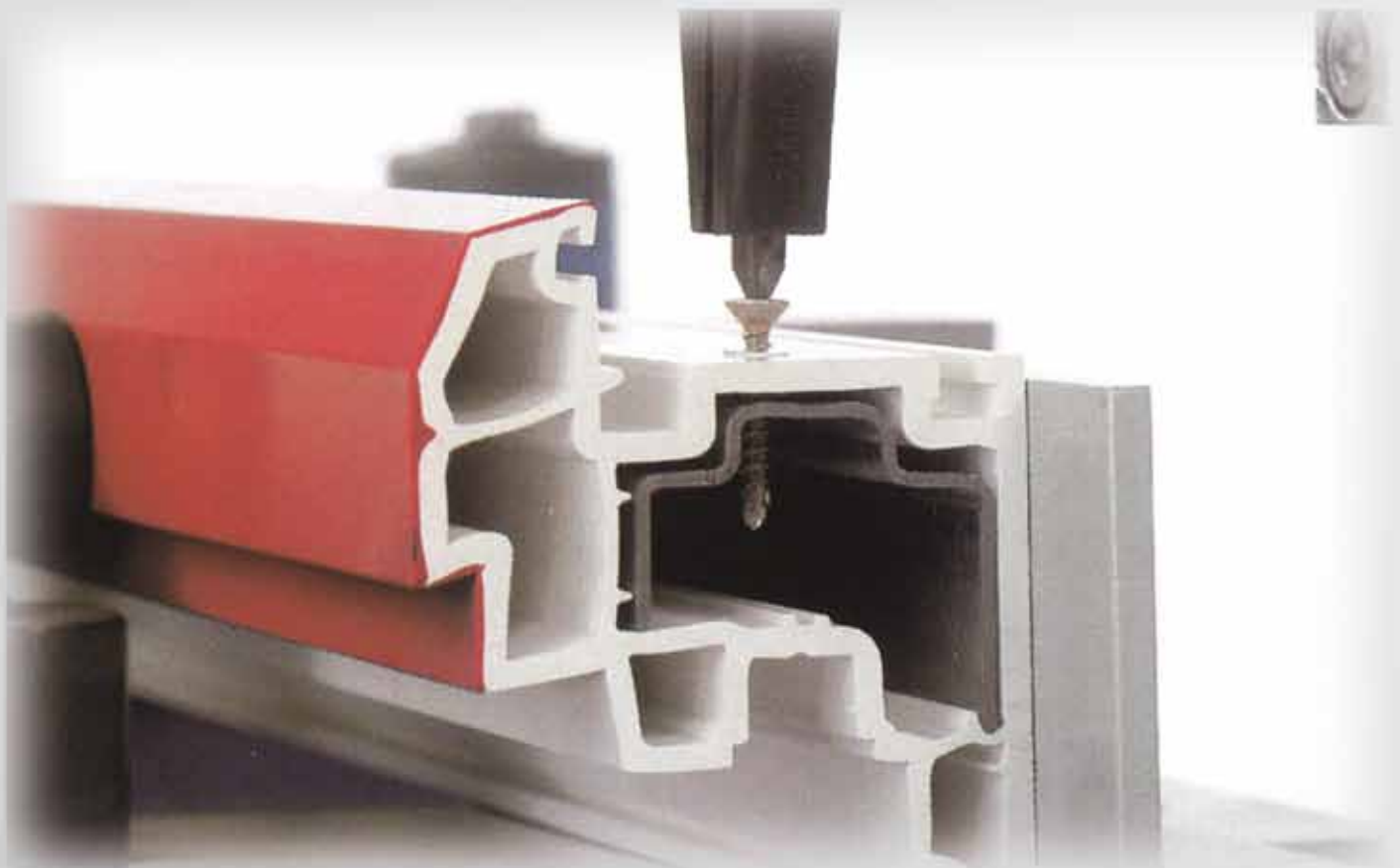
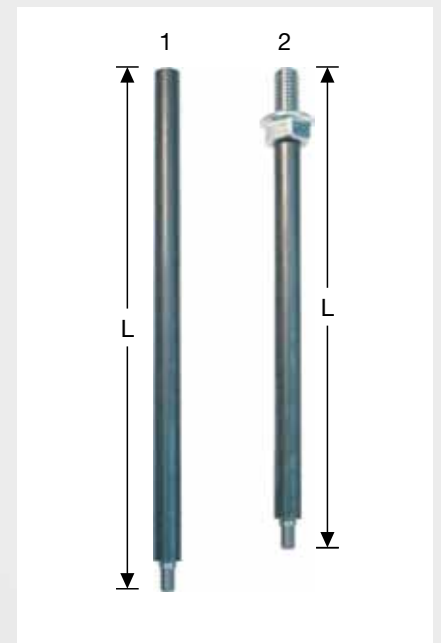



Verglasungshammer

95100

rückschlagsfrei, für Verglasungsarbeiten

Softhammer

non-rebound, for glazing

Art.-Nr.	D	Bild
900 000 035	30	1
900 000 060	25	2



Schonhammer THOREX

95102

mit auswechselbaren Einsätzen

Softhammer THOREX

with removeable pads

Art.-Nr.	D
900 000 069	32 mm / 1,25 inch

Ersatzteile / Spare Parts

Art.Nr.	Beschreibung / Description
900 001 069	Einsätze Screw in faces



Verglasungsschaufeln

95103

aus Kunststoff (1)
aus Holz (2)
aus Kunststoff mit Holzgriff (3)

Glazing paddle

*PVC (1)
Wood (2)
PVC with wooden handle (3)*

Art.-Nr.	B
900 000 059	1
900 000 056	2
900 000 159	3

Stecheisen

95104

Profiqualität, zum Abstechen von PVC-Schweißraupen.

Chisel

professional quality, to remove spread, splitproof handle

Art.-Nr.	B
900 000 105	4
900 000 112	6
900 000 113	8
900 000 106	10
900 000 109	12
900 000 110	14
900 000 107	16
900 000 114	25
900 000 108	30

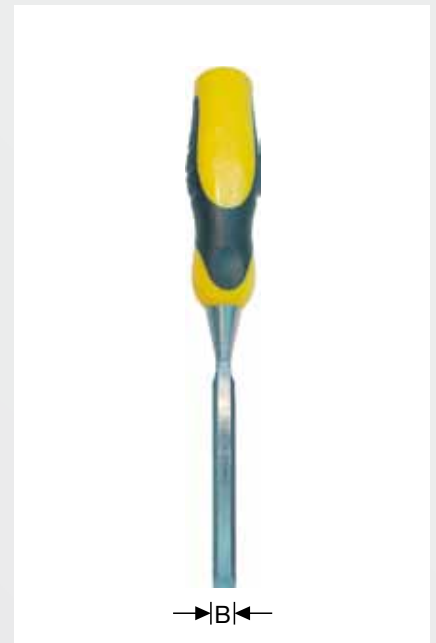

Multi-Tool

95105

Universal-Werkzeug für **JEDEN** Handwerker
gehärtete Edelstahlklinge, schlagfest
- auch bestens geeignet zum Ausbrechen der Glasleisten

Multi-Tool

*All-purpose tool for EVERY craftsmen
hardened stainless steel blade, hammer-end
- also for removing bead from PVC and aluminium windows*

Art.-Nr.
900 000 210



Saugheber

95106

- aus Aluminium, TÜV-geprüft
- für alle Materialien mit glatten und gasdichten Oberflächen wie Glas, Kunststoff, Bleche, beschichtetes Holz, Fliesen, etc.

Suction lifter

*- made of aluminium, TÜV-proofed
- to lift all materials with smooth surface as glass, sheet metal, tiles, etc.*

Art.-Nr.	A	B	
900 000 602	2-Kopf	2-head	70 kg
900 000 604	3-Kopf	3-head	110 kg

Ersatzteile / Spare Parts

Art.Nr.	Beschreibung / Description
900 001 601	Ersatzscheibe suction pad





TEFLON-Folie, Rollenware

95107

PREMIUM-Qualität für PVC-Schweißmaschinen, selbstklebend

TEFLON foil, rolls

Premium quality for UPVC-welding machines, self-stick

Art.-Nr.

900 000 129	200 mm	pro mtr.	per metre
900 000 137	220 mm	pro mtr.	per metre
900 000 130	230 mm	pro mtr.	per metre
900 000 131	240 mm	pro mtr.	per metre
900 000 132	250 mm	pro mtr.	per metre
900 000 133	255 mm	pro mtr.	per metre
900 000 134	320 mm	pro mtr.	per metre
900 000 135	340 mm	pro mtr.	per metre
900 000 136	540 mm	pro mtr.	per metre
900 000 127	1000 mm	pro mtr.	per metre
900 000 128	1000 mm	pro mtr.	per metre

TEFLON-Folie, Stanzzuschnitt

95108

passend für PVC-Schweißmaschinen-Fabrikate wie Actual, elumatec, Hollinger, Soenen, Someco, Stürtz, Urban, Wegoma, etc. Weitere Abmessungen kurzfristig lieferbar !

TEFLON foil

suitable for UPVC-welding machines

as Actual, elumatec, Hollinger, Soenen, Someco, Stürtz, Urban, Wegoma, etc.

Other sizes available upon request !

Art.-Nr.	A	B	
900 510 230	230	510/250	ROTOX
900 440 245	245	440/215	Hollinger
900 250 390	250	390	Urban
900 250 680	250	680	Someco, elumatec Serie 5
900 255 425	255	425	Urban
900 320 460	320	460	Urban AKS
900 340 560	340	560	elumatec 700-730
900 340 680	340	680	Someco, elumatec Serie 5
900 360 350	360	350	Urban AKS
900 535 645	535	645	elumatec 700-730
900 540 680	540	680	Someco, elumatec Serie 5

Sonderwerkzeuge auf Anfrage

Special designed tools upon request

Ausklinkfräser-Sätze HM-bestückt

95620

- nach Profilzeichnung/-Muster
- lieferbare Bohrungen 22/27/32/40 mm
- auch mit Keilnut -

End milling cutters, carbide tipped

- according profile drawing / -sample
- available bore dia 22/27/32/40 mm
- also with keyway -



Verputz-Fräasersätze HM-bestückt

95621

nach Profilzeichnung/-Muster

Corner cleaner cutters, carbide tipped

according profile drawing / -sample

Schweißzulagen

95625

nach Profilzeichnung/-Muster
gefertigt aus hochwertigen Alulegierungen

Welding support blocks

according profile drawing / -sample
made from high quality aluminium to any profile



Säge-Beilagen

95630

Spannsätze nach Profilzeichnung/-Muster
für Glasleisten- und Gehrungssägemaschinen

Saw support blocks

blocks according profile drawing / -sample
for glazing bead- and miter saw machines



Universal-Sprühgerät

95400

als Ersatz und zum nachträglichen, kostengünstigen Anbau an Kopierfräsen, Sägen, Bohreinheiten.

2 Einlässe, a) für Kühlmittel, b) für Druckluft, beide regelbar 0,5 - 5 bar

Universal mist spray unit

for replacement or for supplementary and cheap assembling on copy routers, saws, drilling units, etc.

2 inlet ports, a) coolant, b) compressed air, both adjustable 0,5 - 5 bar

Art.-Nr.

900 227 014 260 mm

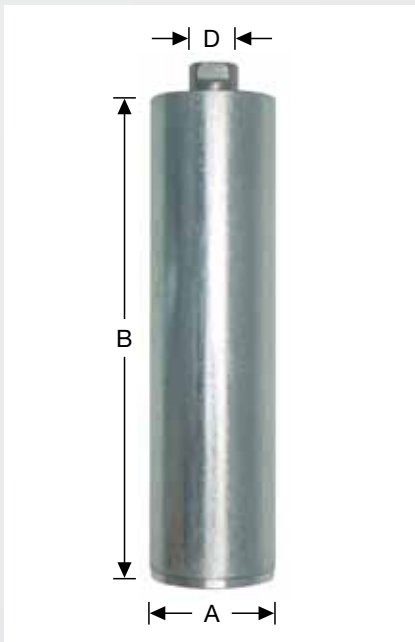

Spannzylinder

95500

einfachwirkend, Pneumatikanschluß 1/8"

M8 IG

C = Hub

Pneumatic clamp cylinder

single action piston stroke, pneumatic connector 1/8"

M8 female thread

C = stroke

Art.-Nr.	A	B	C	D
900 025 100	30	196	100	M8
900 035 405	40	88	5	M8
900 035 040	40	88	40	M8
900 035 080	40	154	80	M8
900 035 120	40	207	120	M8
900 040 080	45	149	80	M8

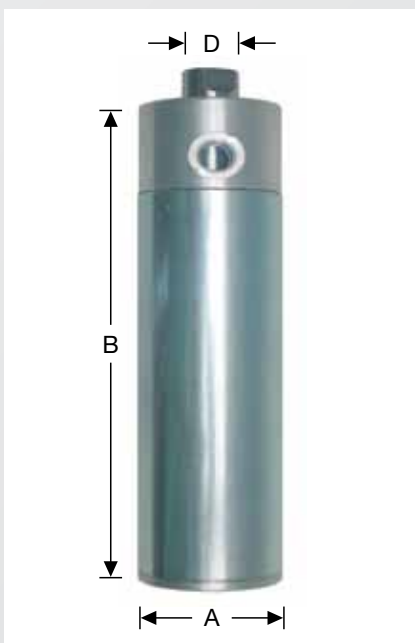

Spannzylinder

95501

doppeltwirkend, Pneumatikanschluß 1/8"

C = Hub

Pneumatic clamp cylinder

double-acting piston stroke, pneumatic connector 1/8"

C = stroke

Art.-Nr.	A	B	C	D		
900 240 080	40	185	80	M8	Innengew.	female th.
900 240 140	40	204	140	M8	Innengew.	female th.
900 245 140	45	204	140	M8	Innengew.	female th.
900 245 125	45	189	125	M10	Innengew.	female th.
900 245 120	45	204	120	M8	Innengew.	female th.
901 240 125	40	189	125	M10	Außengew.	male th.
901 240 140	40	204	140	M10	Außengew.	male th.
901 245 125	45	189	125	M10	Außengew.	male th.
901 245 140	45	204	140	M10	Außengew.	male th.
902 245 080	45	144	80	M12	Außengew.	male th.
902 245 125	45	189	125	M12	Außengew.	male th.

Schwenkverschraubung

95502

1/8" zum Anschluß von Druckluftschläuchen am Spannzylinder

Swivel coupling

1/8" thread to connect air hose with cylinders

Art.-Nr.	A
073 211 805	6/4
102 211 803	8/6

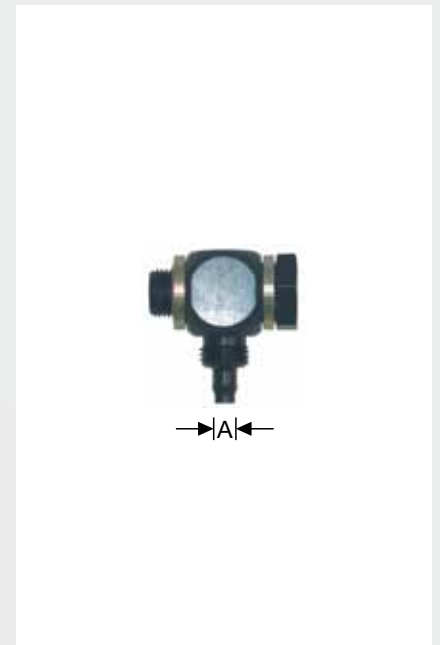

Druckluftschlauch (PE)

95503

A = d-Aussen

B = d-Innen

Air-hose (PE)

A = d-outside

B = d-inside

Art.-Nr.	A	B		
088 207 006	6	4	pro mtr.	per metre
088 207 008	8	6	pro mtr.	per metre



Druckluftschlauch

95504

- hochbelastbar, mit Metallumflechtung

Air-hose

- heavy duty, covered with metal texture

Art.-Nr.	A	B		
088 207 018	7	4	pro mtr.	per metre



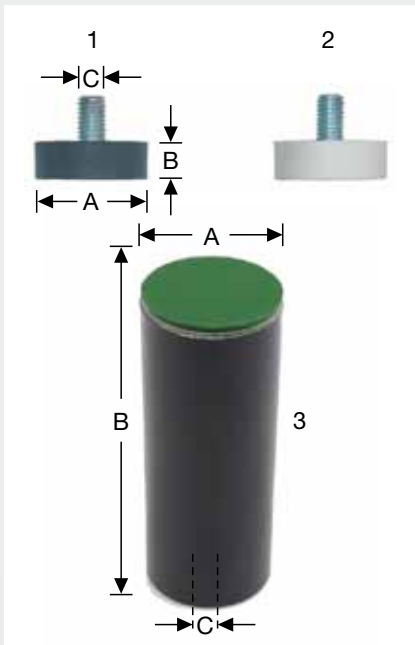

Gummipuffer

95505

passend zu Spannzylindern Gruppe 95500

1 = schwarz - 2 = weiss

Rubber bumper

suitable to pneumatic clamp cylinder group 95500

1 = black - 2 = white

Art.-Nr.	A	B	C	Bild
900 000 230	25	10	6	1
900 000 006	25	20	8	1
900 000 005	30	10	8	1
900 000 167	30	10	8	2
900 000 001	40	10	8	1
900 000 004	40	25	8	1
900 001 004	40	25	8	Innengew. female th.
900 000 011	40	25	10	1
900 001 011	40	25	10	Innengew. female th.
104 040 128	40	100	8	3 Innengew. female th.
104 040 112	40	100	12	3 Innengew. female th.
244 060 128	60	100	8	3 Innengew. female th.
244 060 112	60	100	12	3 Innengew. female th.

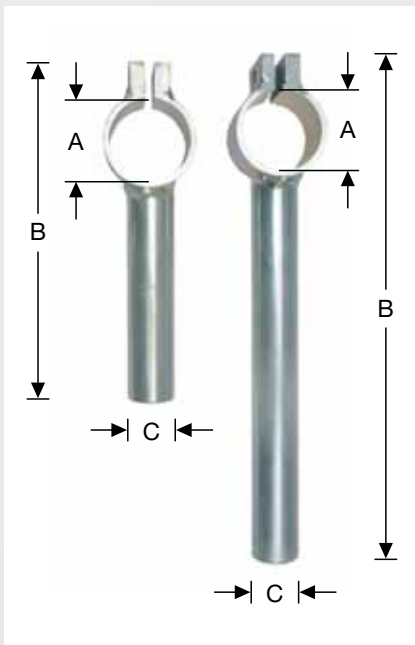

Spannhalterarme

95506

für Pneumatikzylinder Gruppe 95500

- verzinktes Stahlrohr -

Holder

for pneumatic cylinders group 95500

- galvanized steel -

Art.-Nr.	A	B	C
079 111 804	40	110	25
078 216 902	40	200	25

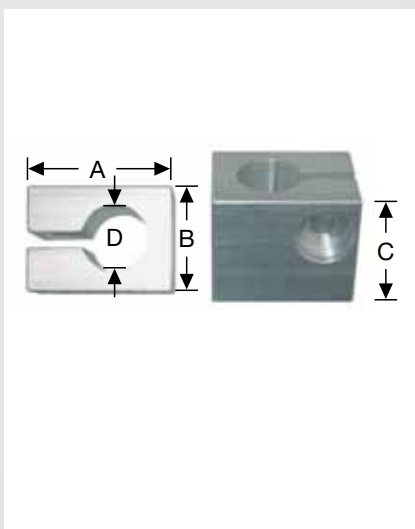

Spannhalter

95507

passend für Spannarme Gruppe 95506.

Zum Anschrauben an die Maschine.

Clamp holder

fits to holders group 95506

- aluminium -

Art.-Nr.	A	B	C	D
079 116 533	55	40	45	25

Klemmhebel

95510

mit Gewindebolzen

Handle

with male thread bolt

Art.-Nr.	A	B
078 233 200	6	15
078 233 203	6	25
078 233 207	6	40
078 233 211	6	50
078 233 213	6	60
078 233 201	8	20
078 233 204	8	40
078 233 206	8	50
078 233 214	8	60
078 233 220	8	70
078 233 221	8	80
078 233 205	10	40
078 233 202	10	50
078 233 215	10	60
078 233 209	10	85
078 233 216	12	30
078 233 217	12	40
078 233 218	12	60
078 233 212	12	70
078 233 219	12	90



Klemmhebel

95511

mit Innengewinde

Handle

with female thread

Art.-Nr.	A
011 233 201	M6
013 233 200	M8
011 233 200	M10
011 233 202	M12





Zuführschlauch für Schraubeinheiten

95512

mit Gewindebolzen

- PU-Schlauch natur
- für alle gängigen Schraubautomaten, z.B. POWASERT, KS, Taubert, Weber

Screw delivery hose for screw-unit

with male thread bolt

- PU-material transparent
- for most screw feeders, e.g. POWASERT, KS, Taubert, Weber

Art.-Nr.	A		
088 207 711	7/11 mm	pro mtr.	per metre
088 207 813	8/13 mm	pro mtr.	per metre
088 207 914	9/14 mm	pro mtr.	per metre
088 207 107	10/15 mm	pro mtr.	per metre



Magnet

95513

- starke Ausführung, mit Mittelloch
- für Schweißzulagen, Profilbeilagen

Magnet

- heavy duty, with screw hole
- for welding profile contour blocks, etc....

Art.-Nr.	A	B	C
900 000 094	20	8	M5
900 000 091	25	8	M5
900 000 092	32	8	M5
900 000 090	40	8	M5

Profilleisten

95516

- Länge 2000 mm
- C-Profilschiene/Stahl (1)
 - Pilzleiste, PE grün (2)
 - Bürstenleiste, 3-reihig (3)
 - Spezialverpackung erforderlich - gegen Aufpreis

Glide strip

- length 2000 mm
- steel channel (1)
 - mushroom ledge PE green (2)
 - brush glide strip (3)
 - special packaging necessary - extra costs

Art.-Nr.	A
900 000 400	1
900 000 402	2
900 000 401	3



Gummi-Profil

95517

- Rollenware per Meter
- rutschfest, für Montagetisch, Transportgestelle

Rubber profile

- rolls, per metre
- slip resistant, for assembling tables, trolleys, profile transportation, glass-handling

Art.-Nr.	A
900 000 405	1
900 000 406	2



Skalenbänder

95600

- für Mess-Systeme, Längenanschläge, etc.
- von **Rechts nach Links**

- 1 = Polyamid-beschichtet, Farbe gelb
- 2 = lackiert, Farbe weiss

Scale tapes

- for measuring systems, length stops, etc.
- **RH to LH**

- 1 = Polyamid-coated, yellow colour
- 2 = painted, white colour

Art.-Nr.	A	B	C
000 150 020	0 - 2 m	13 mm	1
000 150 030	0 - 3 m	13 mm	1
000 350 030	0 - 3 m	13 mm	2
000 150 050	0 - 5 m	13 mm	1
000 350 050	0 - 5 m	13 mm	2
000 150 100	0 - 10 m	13 mm	1
000 350 100	0 - 10 m	13 mm	2
000 150 150	0 - 15 m	13 mm	1

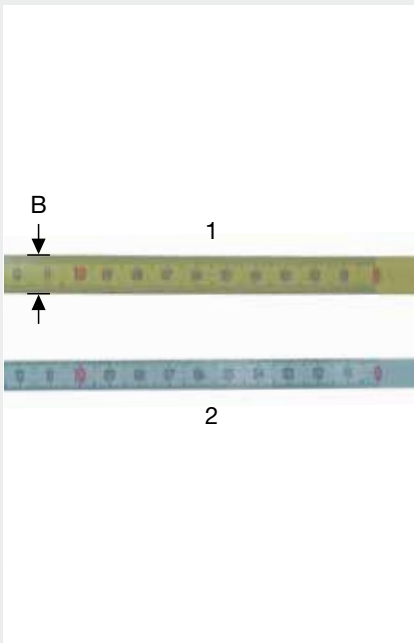

Skalenbänder

95601

- für Mess-Systeme, Längenanschläge, etc.
- von **Links nach Rechts**

- 1 = Polyamid-beschichtet, Farbe gelb
- 2 = lackiert, Farbe weiss

Scale tapes

- for measuring systems, length stops, etc.
- **LH to RH**

- 1 = Polyamid-coated, yellow colour
- 2 = painted, white colour

Art.-Nr.	A	B	C
000 151 020	0 - 2 m	13 mm	1
000 151 030	0 - 3 m	13 mm	1
000 351 030	0 - 3 m	13 mm	2
000 151 050	0 - 5 m	13 mm	1
000 351 050	0 - 5 m	13 mm	2
000 151 100	0 - 10 m	13 mm	1
000 351 100	0 - 10 m	13 mm	2
000 151 150	0 - 15 m	13 mm	1

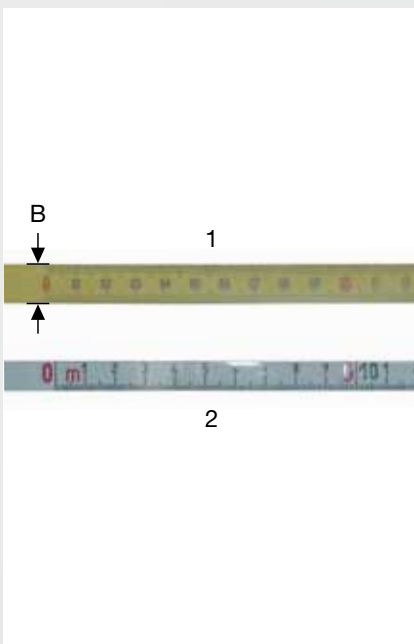

Skalenbänder, selbstklebend

95603

- für Mess-Systeme, Längenanschlüsse, etc.
- von **Rechts nach Links**

1 = Polyamid-beschichtet, Farbe gelb

2 = lackiert, Farbe weiss

Scale tapes, self-adhesive

- for measuring systems, length stops, etc.

- **RH to LH**

1 = Polyamid-coated, yellow colour

2 = painted, white colour

Art.-Nr.	A	B	C
000 250 020	0 - 2 m	13 mm	1
000 450 020	0 - 2 m	10 mm	2
000 450 030	0 - 3 m	10 mm	2
000 250 030	0 - 3 m	13 mm	1
000 450 050	0 - 5 m	10 mm	2
000 250 050	0 - 5 m	13 mm	1
000 450 100	0 - 10 m	10 mm	2
000 250 100	0 - 10 m	13 mm	1

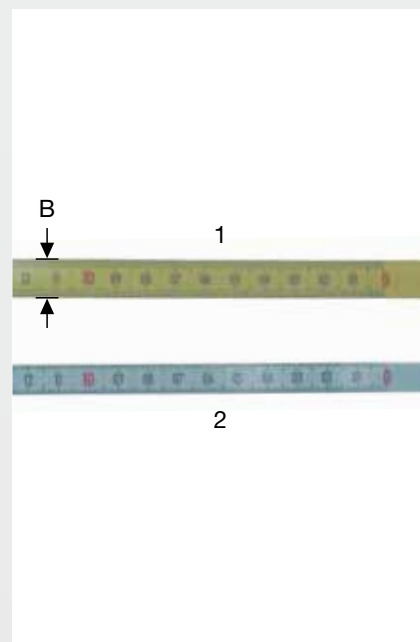

Skalenbänder, selbstklebend

95604

- für Mess-Systeme, Längenanschlüsse, etc.
- von **Links nach Rechts**

1 = Polyamid-beschichtet, Farbe gelb

2 = lackiert, Farbe weiss

Scale tapes, self-adhesive

- for measuring systems, length stops, etc.

- **LH to RH**

1 = Polyamid-coated, yellow colour

2 = painted, white colour

Art.-Nr.	A	B	C
000 451 020	0 - 2 m	10 mm	2
000 251 020	0 - 2 m	13 mm	1
000 451 030	0 - 3 m	10 mm	2
000 251 030	0 - 3 m	13 mm	1
000 451 050	0 - 5 m	10 mm	2
000 251 050	0 - 5 m	13 mm	1
000 451 100	0 - 10 m	10 mm	2
000 251 100	0 - 10 m	13 mm	1

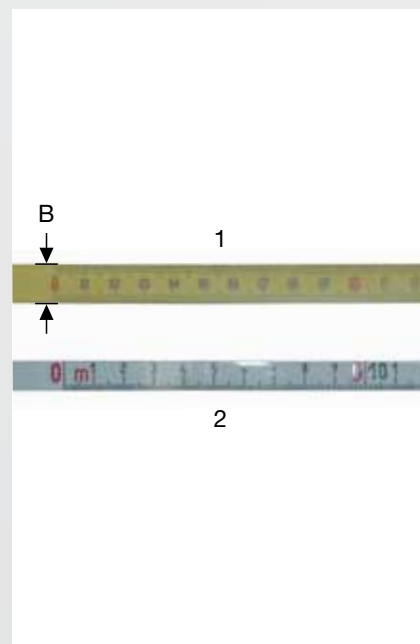



Sonderanfertigungen für die zerspanende Industrie
Custom-made tools for the machining industry



Lieferbedingungen

- Ab Werk, zzgl. Verpackung
- Mindestbestellwert:
Deutschland: 25,- €
EU: 50,- €
Drittland: 100,- €
- Es wird die preiswerteste Versandart zugrunde gelegt. Mehrkosten für Eilversand, Versicherungen usw. trägt der Auftraggeber, soweit sie von ihm vorgeschrieben sind

Zahlungsbedingungen

- Zahlungsbedingungen nach Vereinbarung

Anmerkungen

- Die gelieferte Ware bleibt bis zur vollständigen Bezahlung aller Forderungen unser Eigentum
- Bei Rücksendungen, die nicht durch uns verschuldet sind, wird an der Gutschrift neben den entstandenen Kosten eine Bearbeitungsgebühr in Abzug gebracht
- Sonderanfertigungen, Reparaturen oder Waren, die nicht mehr den geltenden Standards entsprechen, können grundsätzlich nicht zurückgenommen werden
- Auf Grund des technischen Fortschritts müssen wir uns Abweichungen bei Abbildungen, Zeichnungen und Ausführungen vorbehalten

Delivery terms and conditions

- Ex factory, without packaging
- Minimum order value:
Germany: 25,- €
EU: 50,- €
Others: 100,- €
- We choose always the most economical way of delivery. If special carriage (urgent or with special parcel service) is required from the customer, he pays for the extra charge

Payment conditions

- Upon request

Remarks

- Delivered products stay in our property until complete payment
- Returns, through no fault of us, may be returned by prior agreement of the company. They must be undamaged and fully marketable. We reserve the right to make a credit note with restocking and administration charge
- Specially manufactured tools, repairs of goods which don't correspond at the actual valid standards, can not be returned
- Because of the ongoing technical evolution, data, dimensions and design are given as a guide and does not mean that the goods will conform in absolute detail to the descriptions and illustrations

Impressum

Herausgeber: **WEMARO® TOOLS GmbH, Max-Eyth-Str. 7, 75428 Illingen**

Satz und Layout: KÖHLER-FEINAUER, 73635 Rudersberg, www.koehler-feinauer.de

Druck und Weiterverarbeitung: wüth druck GmbH & Co. KG, 73635 Rudersberg, www.wuerthdruck.de

Änderungen und Irrtümer sind vorbehalten.

Ein Nachdruck ohne Genehmigung des Herausgebers ist verboten.

Schutzgebühr: 5,- €

MKF 240438 · Ausgabe 2017



WEMARO® TOOLS GmbH

Postfach 11 47 · Max-Eyth-Straße 7 · D-75428 Illingen

Tel.: +49 (0) 70 42 / 82 63 - 0 · Fax: +49 (0) 70 42 / 82 63 - 23

E-Mail: verkauf@wemaro.de · Internet: www.wemaro.de



Präzise . Schnell . Innovativ

WEMARO