

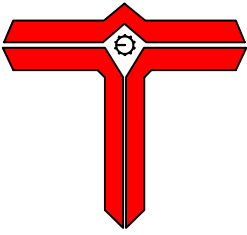

TAAALIN
MACHINERY & ROBOTICS PVT LTD

CATALOGUE

PROFILE MACHINING CENTER	01
<ul style="list-style-type: none"> 1.CNC PROFILE MACHINING CENTER 4M (MC-4XA) 2. CNC PROFILE MACHINING CENTER 3M (PMC-3M3) 3.CNC PROFILE MACHINING CENTER (MC 4X) 4.CNC PROFILE MACHINING CENTER (MC 3X) 	
<hr/>	
PROFILE CUTTING MACHINE	02
<ul style="list-style-type: none"> 1.DOUBLE HEAD CUTTING 600 (SDM 24AA) 2.DOUBLE HEAD CUTTING 530/550 (SDM/SDA 21/22) 3.DOUBLE HEAD CUTTING MACHINE500mm (GARUDA) 4.DOUBLE HEAD CUTTING - 500 (SDM/SDA 20A) 5.DOUBLE HEAD CUTTING 420 (SDM/SDA 17A) 6.SINGLE HEAD CUTTING 500 SAW (SSM 20F) 	
<hr/>	
PROFILE CORNER WELDING MACHINE	03
<ul style="list-style-type: none"> 1.QUAD WELDING MACHINE (WQSS) 2.SEAMLESS FOUR HEAD WELDING MACHINE(WTS S6LVVL) 3.SEAMLESS 3- HEAD WELDING (WTS S6 LVL) 4.NEAT SEAMLESS DOUBLE HEAD WELDING MACHINE (WDS SC7L) 5.SEAMLESS DOUBLE HEAD WELDING MACHINE (WDS S6L) 	
<hr/>	
CNC CORNER CLEANING MACHINE	04
<ul style="list-style-type: none"> 1.CNC CORNER CLEANING MACHINE (CCM - 10 AR) 2.CNC CORNER CLEANING MACHINE (CCM - 7T) 3.CNC CORNER CLEANING MACHINE (CCM - 5T) 4.CNC CORNER CLEANING MACHINE (CCM - 3T) 	
<hr/>	
COPY ROUTER MACHINE	05
<ul style="list-style-type: none"> 1.SEMI COPY ROUTER WITH TRIPLE DRILL (RAC/RAC 3D AL) 2.COPY ROUTER WITH TRIPPLE DRILLING (RC AL / RC 3D) 3.COPY ROUTER (RC - AL) 	
<hr/>	
WATER SLOT MACHINE	06
<ul style="list-style-type: none"> 1.WATER DRAIN SLOT WITH 3- SPINDLE (RWS - 3S) 	
<hr/>	
SPECIAL MACHINES	07
<ul style="list-style-type: none"> 1.UNIVERSAL GLAZING BEAD SAW (SGB 100A) 2.AUTOMATIC END MILLING MACHINE (ME 5A/ME 5A - AL/ UPVC) 3.AUTOMATIC V CUT SAW (SVC 2A8) 4.CNC DIGITAL MOTOR BODY CUTTING (SCC-20A) 5.CNC DIGITAL CLEAT MACHINE (SCC-18A) 6.ARC BENDING MACHINE (BUA - 300) 	



MC 4XA CNC PROFILE MACHINING CENTER 4M

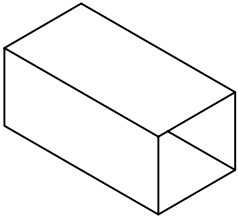

Electro Spindle
7.5Kw / 24000 RPM

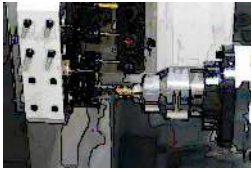

11 Tool ATC

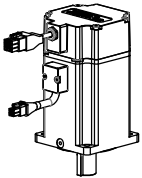

1 Kw X 1
0.75 Kw X 3
Servo Motor

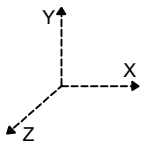

4 Axis movement
X MAX - 4000mm
Y MAX - 375mm
Z MAX - 350mm
A MAX - 180 Degree

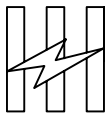
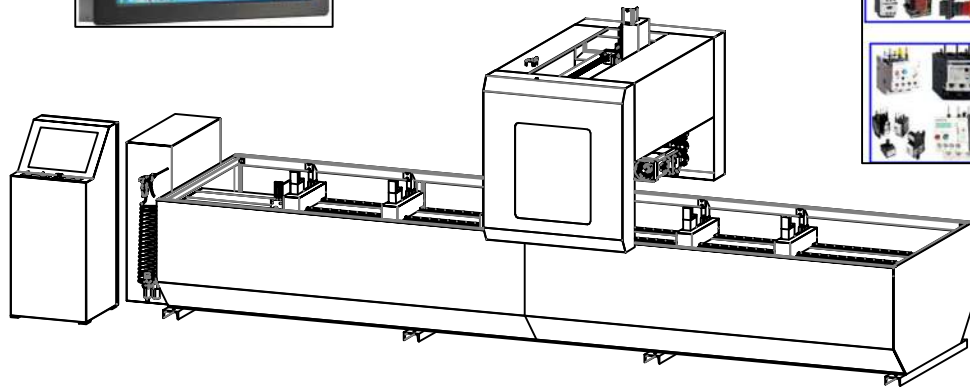

THREE-PHASE
400 volt

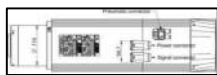

7.5 KW
AUTOMATIC TOOL
CHANGER WITH FAN

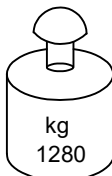

WEIGHT
kg
1280



6-7 BAR



AIR
CONSUMPTION
30 L/M

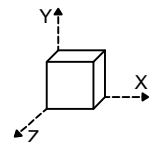

DIMENSIONS
L- 2820mm
H- 1820mm
W- 1550mm

PACKAGING
L- 2900mm
H- 1900mm
W- 1650mm

TAALIN MACHINERY & ROBOTICS PVT. LTD.

931/931A, Winsten Park, Knowledge Park-V, Greater Noida West, U.P- 201308 (INDIA)

Web: <https://www.taalin.com>, Mail id: sales@taalin.com, Mob: 8882033535/8882910477

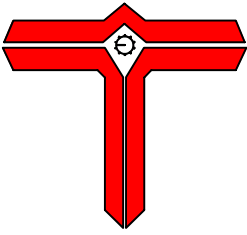

PMC 3M3 CNC PROFILE MACHINING CENTER 3M

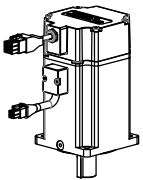
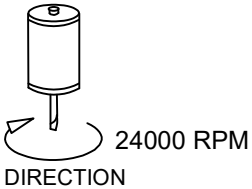
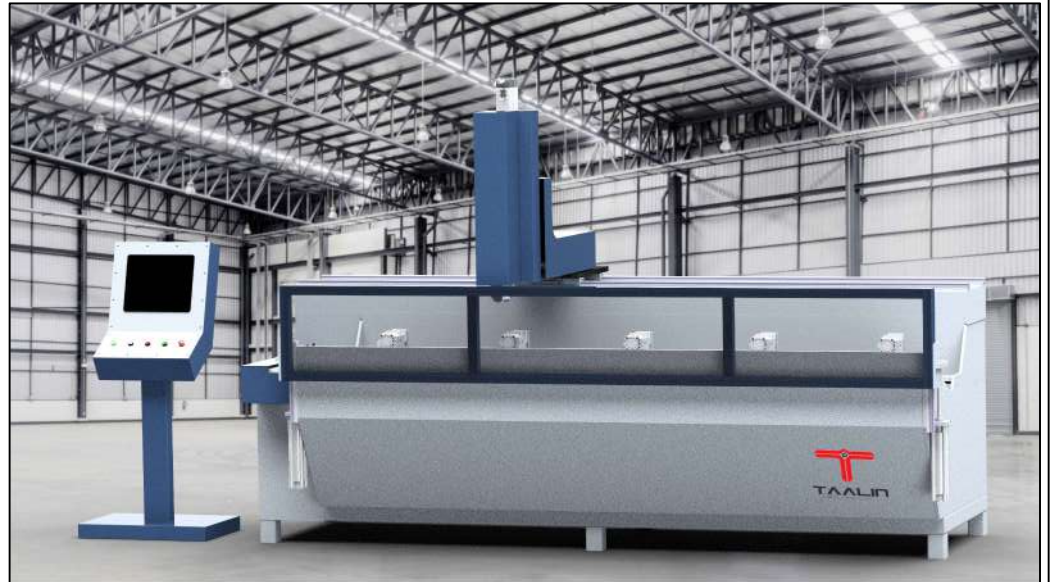
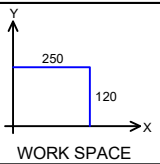
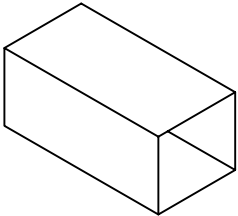

0.75 KW x3
Servo motor

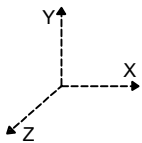

3 Axis movement
X MAX - 2500mm
Y MAX - 375mm
Z MAX - 350mm

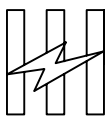
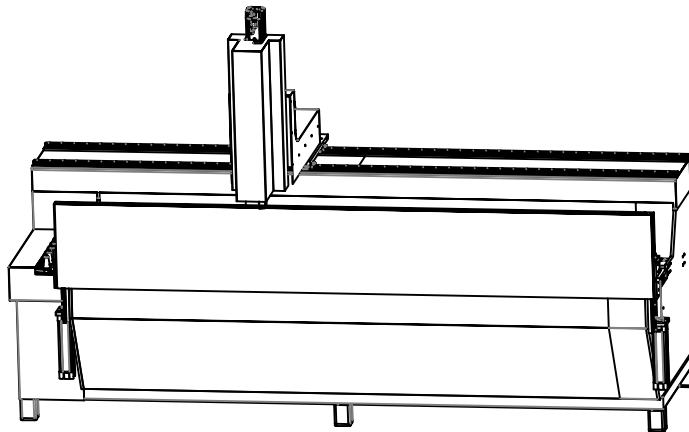
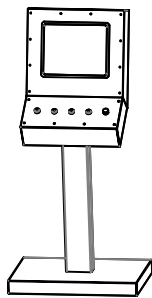

THREE-PHASE
400 volt

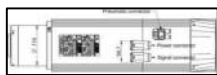

7.5 KW
AUTOMATIC TOOL
CHANGER WITH FAN

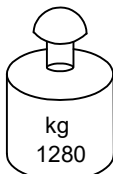

WEIGHT
kg
1280



6-7 BAR



AIR
CONSUMPTION
30 L/M

DIMENSIONS
L- 2820mm
H- 1820mm
W- 1550mm

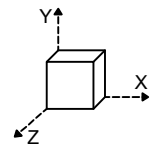

PACKAGING
L- 2900mm
H- 1900mm
W- 1650mm

TAALIN MACHINERY & ROBOTICS PVT. LTD.

931/931A, Winsten Park, Knowledge Park-V, Greater Noida West, U.P- 201308 (INDIA)

Web: <https://www.taalin.com>, Mail id: sales@taalin.com, Mob: 8882033535/8882910477

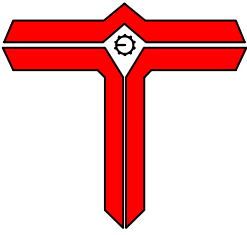

MC 4X

CNC PROFILE MACHINING CENTER MINI

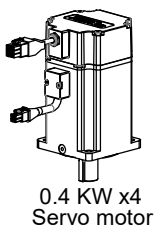
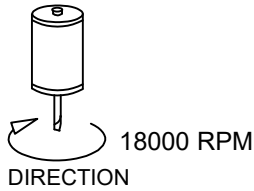
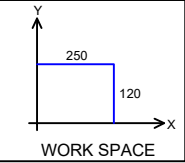
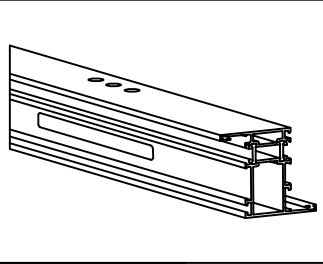

0.4 KW x4 Servo motor

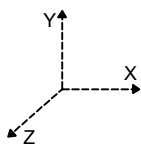

4 Axis movement
X MAX - 1150mm
Y MAX - 190/290mm
Z MAX - 350mm
A MAX - 180 Degree

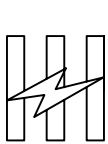
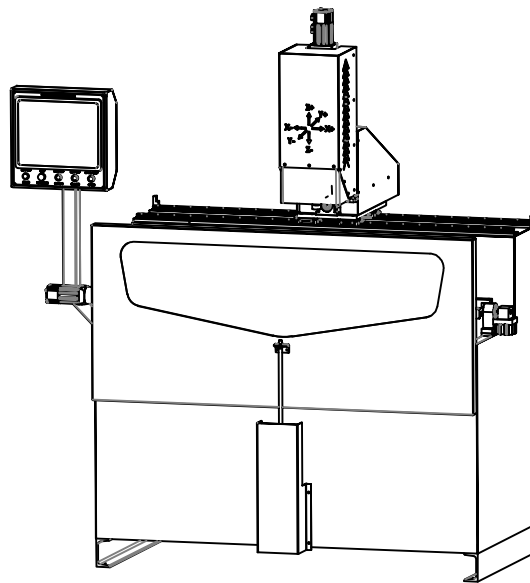

THREE-PHASE
400 volt

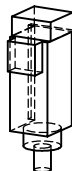

5 KW
SPINDLE MOTOR

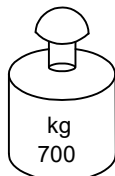

WEIGHT
kg
700



6-7 BAR



AIR
CONSUMPTION
30 L/M

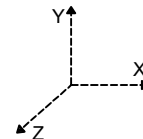

DIMENSIONS
L- 1400mm
H- 1500mm
W- 930mm

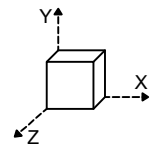

PACKAGING
L- 1500mm
H- 1600mm
W- 1000mm

TAALIN MACHINERY & ROBOTICS PVT. LTD.

931/931A, Winsten Park, Knowledge Park-V, Greater Noida West, U.P- 201308 (INDIA)

Web: <https://www.taalin.com>, Mail id: sales@taalin.com, Mob: 8882033535/8882910477

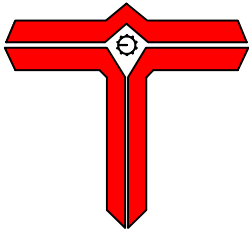

MC 3X

CNC PROFILE MACHINING CENTER MINI

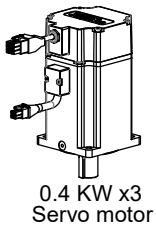
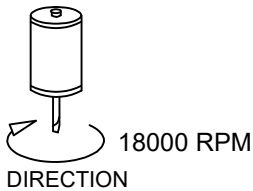
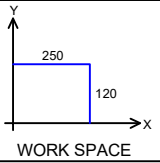
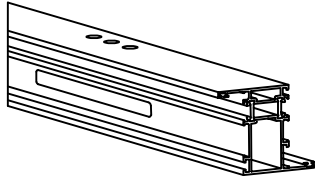

0.4 KW x3 Servo motor

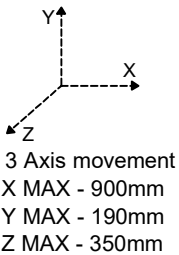

3 Axis movement
X MAX - 900mm
Y MAX - 190mm
Z MAX - 350mm

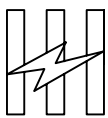
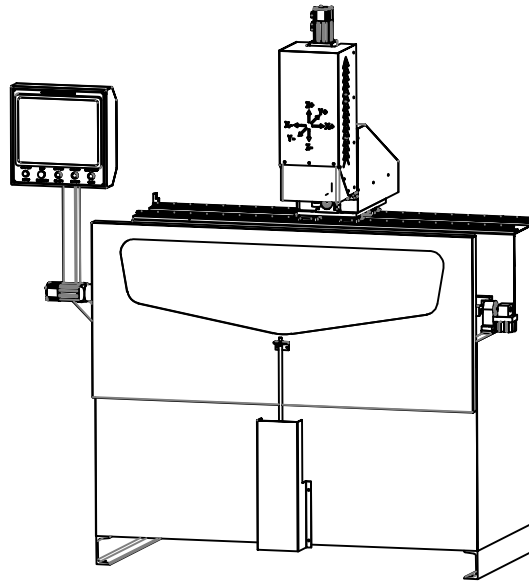

THREE-PHASE
400 volt

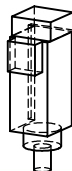

3.5 KW
SPINDLE MOTOR

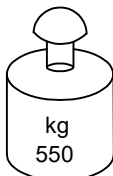

WEIGHT
kg
550



6-7 BAR



AIR
CONSUMPTION
30 L/M

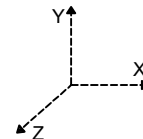

DIMENSIONS
L- 1400mm
H- 1500mm
W- 930mm

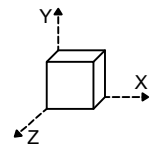

PACKAGING
L- 1500mm
H- 1600mm
W- 1000mm

TAALIN MACHINERY & ROBOTICS PVT. LTD.

931/931A, Winsten Park, Knowledge Park-V, Greater Noida West, U.P- 201308 (INDIA)

Web: <https://www.taalin.com>, Mail id: sales@taalin.com, Mob: 8882033535/8882910477

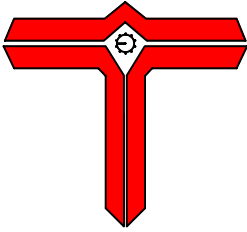

SDM 24AA

DOUBLE HEAD CUTTING 600

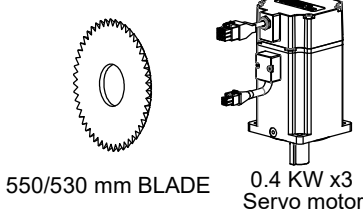
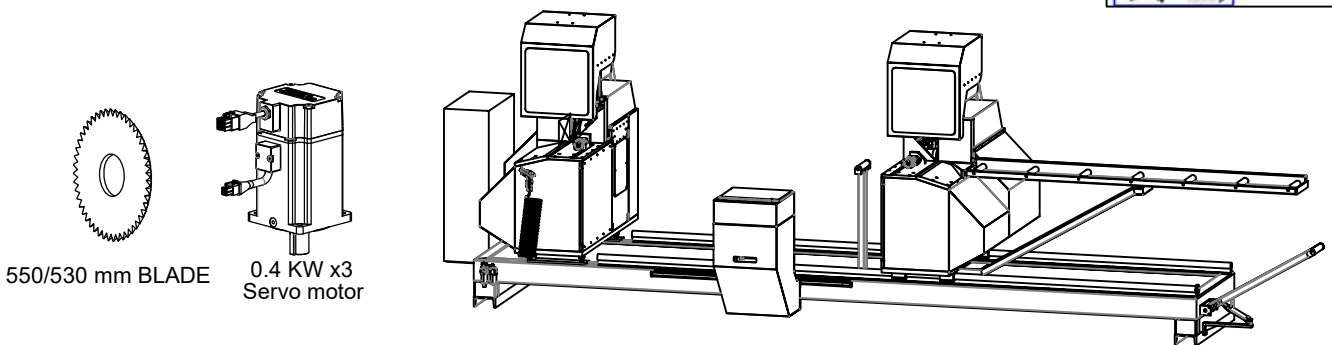
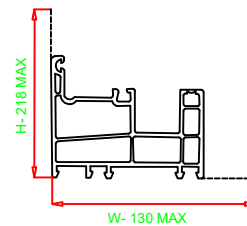
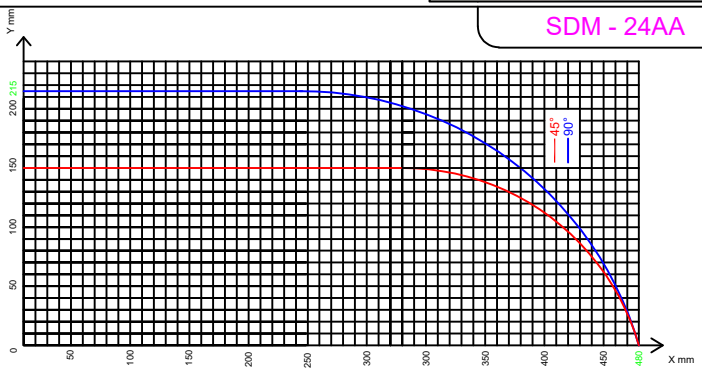
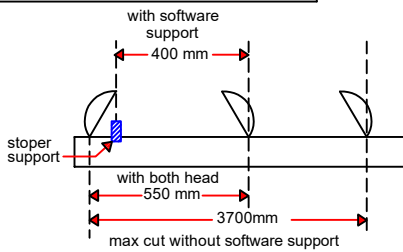

THREE-PHASE 400 volt	3.5 KW x2 2800 rpm	DIRECTION	WEIGHT kg 1800	6-7 BAR	AIR CONSUMPTION 100 LPM	DIMENSIONS L - 5180mm H - 1620mm W- 1000mm	PACKAGING L - 5280mm H - 1700mm W- 1100mm

TAALIN MACHINERY & ROBOTICS PVT. LTD.

931/931A, Winsten Park, Knowledge Park-V, Greater Noida West, U.P- 201308 (INDIA)
 Web: <https://www.taalin.com>, Mail id: sales@taalin.com, Mob: 8882033535/8882910477

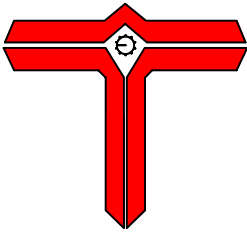

SDM/SDA 21/22

DOUBLE HEAD CUTTING 530/550

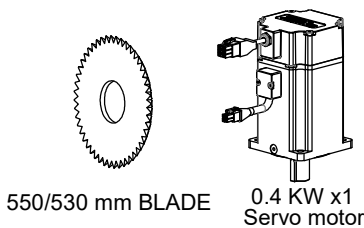
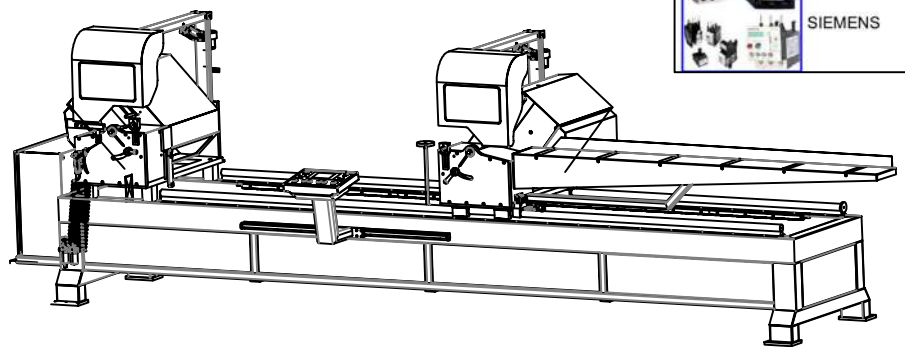
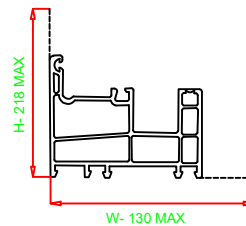
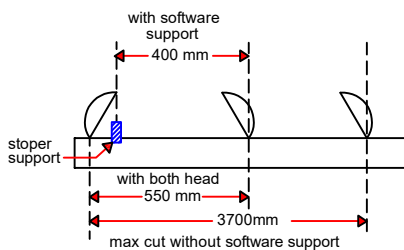
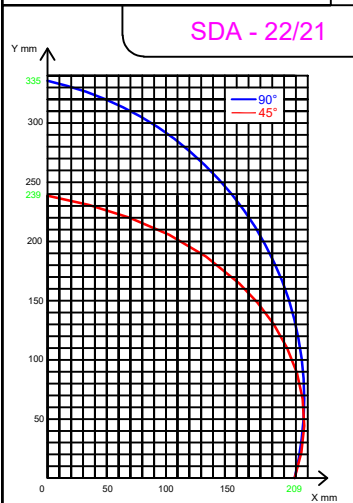
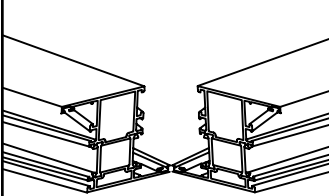

THREE-PHASE 400 volt	3.5 KW x2 2800 rpm	DIRECTION	WEIGHT kg 1350	6-7 BAR	AIR CONSUMPTION 100 LPM	DIMENSIONS L - 5180mm H - 1620mm W - 1000mm	PACKAGING L - 5280mm H - 1700mm W - 1100mm

TAALIN MACHINERY & ROBOTICS PVT. LTD.

931/931A, Winsten Park, Knowledge Park-V, Greater Noida West, U.P- 201308 (INDIA)
 Web: <https://www.taalin.com>, Mail id: sales@taalin.com, Mob: 8882033535/8882910477

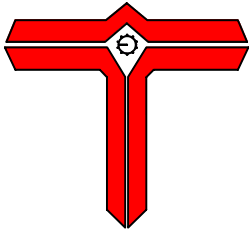

SDM 20FA (GARUDA) DOUBLE HEAD CUTTING 500

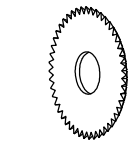
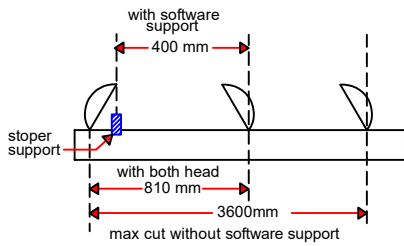
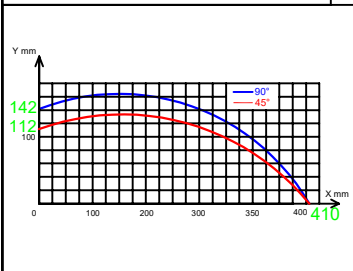
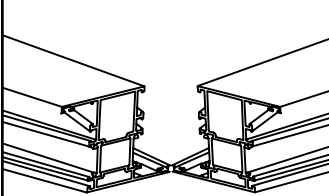

500 mm BLADE

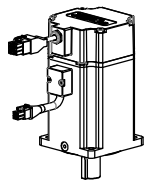

0.4 KW x1 Servo motor

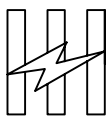
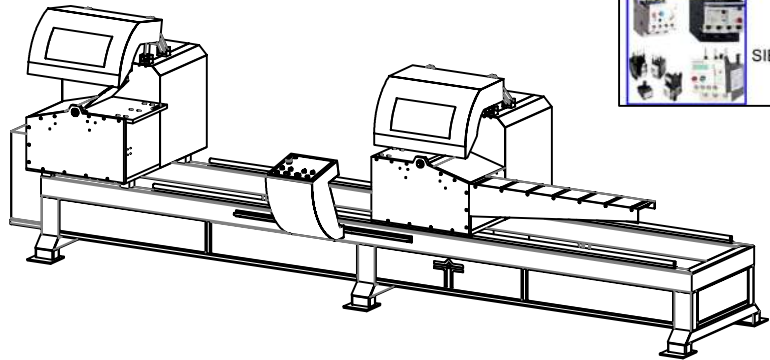

THREE-PHASE
400 volt

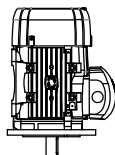

2.2 KW x2
2800 rpm

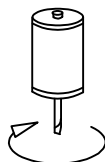

DIRECTION

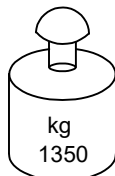

WEIGHT
kg
1350



6-7 BAR



AIR CONSUMPTION
100 LPM

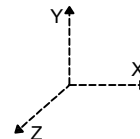

DIMENSIONS
L- 5100+1300mm
H- 1600mm
W- 1500mm

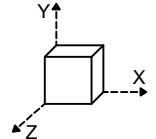

PACKAGING
L- 5160mm
H- 1660mm
W- 1560mm

TAALIN MACHINERY & ROBOTICS PVT. LTD.

931/931A, Winsten Park, Knowledge Park-V, Greater Noida West, U.P- 201308 (INDIA)

Web: <https://www.taalin.com>, Mail id: sales@taalin.com, Mob: 8882033535/8882910477

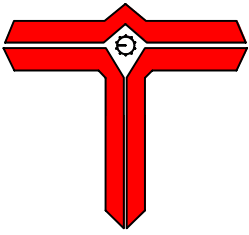

SDM/SDA 20A

DOUBLE HEAD CUTTING 500

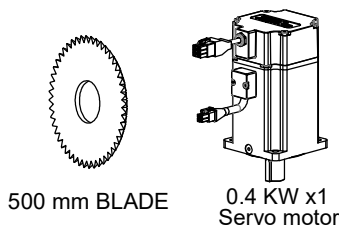
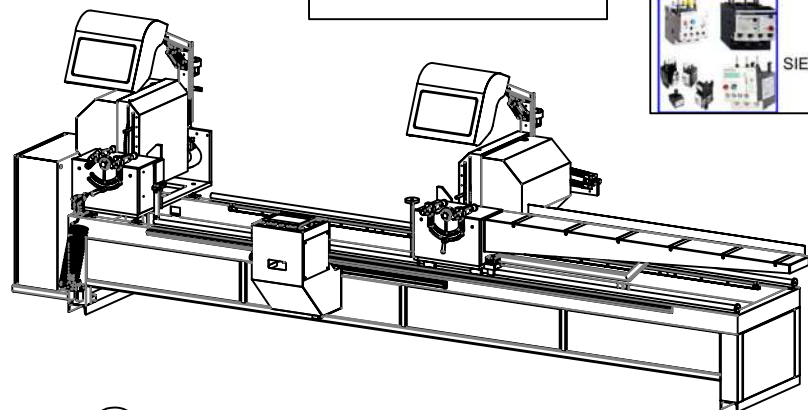
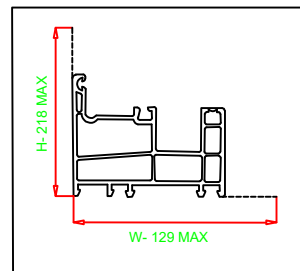
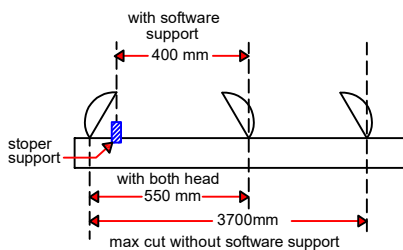
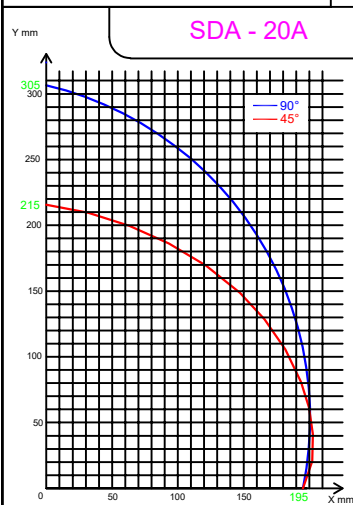
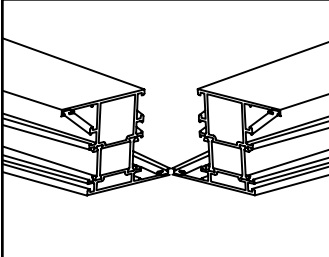

THREE-PHASE 400 volt	2.2 KW x2 2800 rpm	DIRECTION	WEIGHT kg 950	6-7 BAR	AIR CONSUMPTION 100 LPM	DIMENSIONS L - 5190mm H - 1620mm W - 1321mm	PACKAGING L - 5260mm H - 1680mm W - 1400mm

TAALIN MACHINERY & ROBOTICS PVT. LTD.

931/931A, Winsten Park, Knowledge Park-V, Greater Noida West, U.P- 201308 (INDIA)
 Web: <https://www.taalin.com>, Mail id: sales@taalin.com, Mob: 8882033535/8882910477

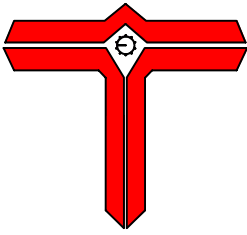

SDM/SDA 17A DOUBLE HEAD CUTTING 420

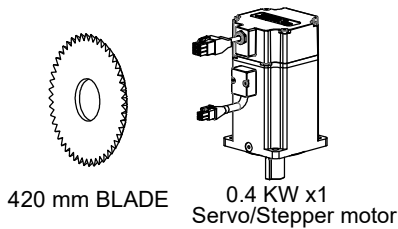
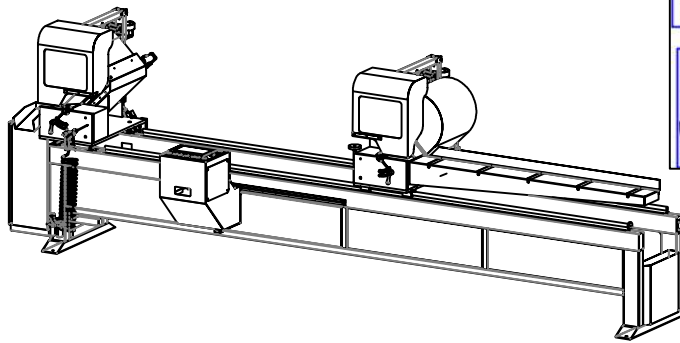
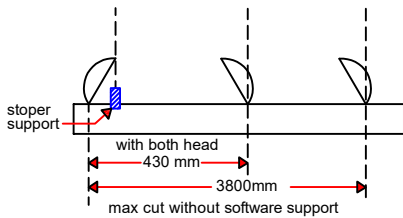
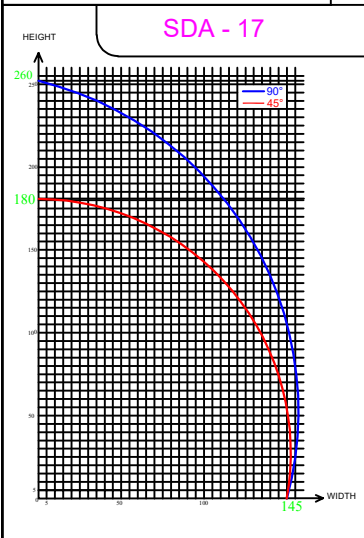
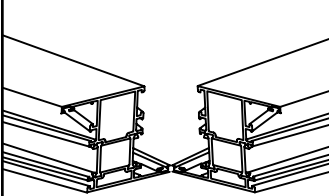

THREE-PHASE 400 volt	1.5 KW x2 2800 rpm	DIRECTION	WEIGHT kg 550	6-7 BAR	AIR CONSUMPTION 100 LPM	DIMENSIONS L- 3680mm H- 1410mm W- 560mm	PACKAGING L- 3760mm H- 1570mm W- 640mm

TAALIN MACHINERY & ROBOTICS PVT. LTD.

931/931A, Winsten Park, Knowledge Park-V, Greater Noida West, U.P- 201308 (INDIA)

Web: <https://www.taalin.com>, Mail id: sales@taalin.com, Mob: 8882033535/8882910477

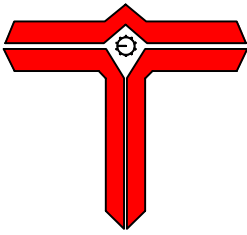

SSM 20F SINGLE HEAD CUTTING 500 SAW

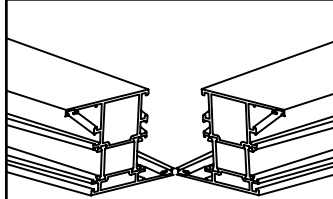

SSM - 18F

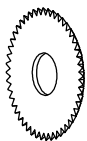
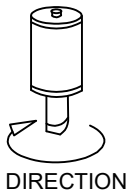
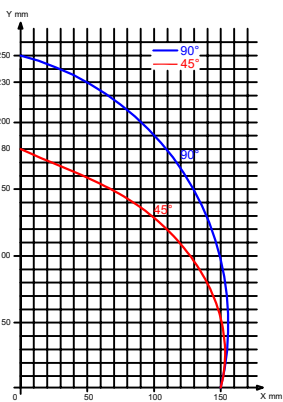

450 mm BLADE
ID 130 mm

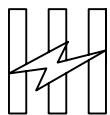

THREE-PHASE
400 volt

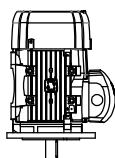

1.5 KW

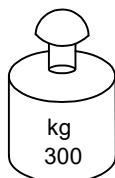

WEIGHT



6-7 BAR



AIR
CONSUMPTION
40 L/M

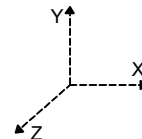

DIMENSIONS
L- 920mm
H- 1500mm
W- 770mm

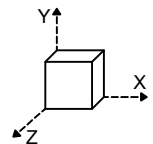

PACKAGING
L- 1000mm
H- 1600mm
W- 880mm

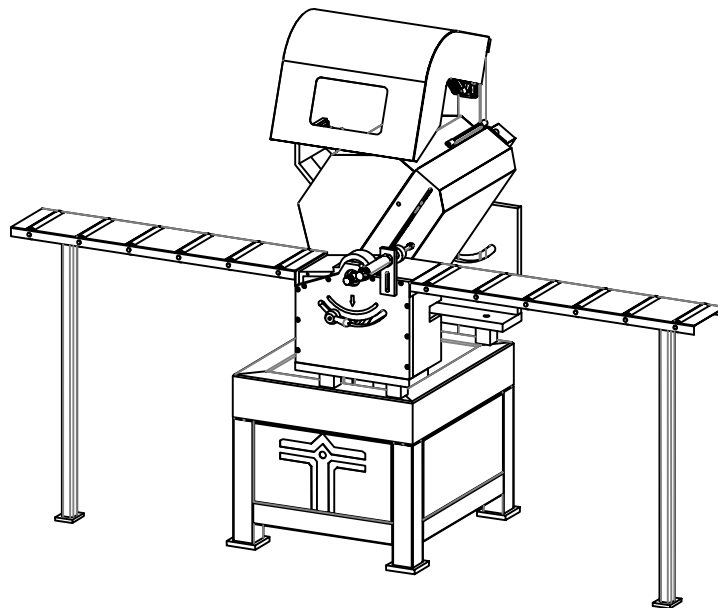

TAALIN MACHINERY & ROBOTICS PVT. LTD.

931/931A, Winsten Park, Knowledge Park-V, Greater Noida West, U.P- 201308 (INDIA)
Web: <https://www.taalin.com>, Mail id: sales@taalin.com, Mob: 8882033535/8882910477

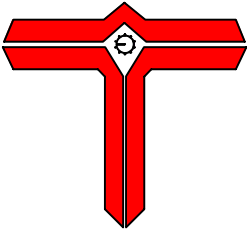

WQSS QUAD WELDING MACHINE

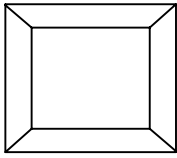

CORNER JOINT

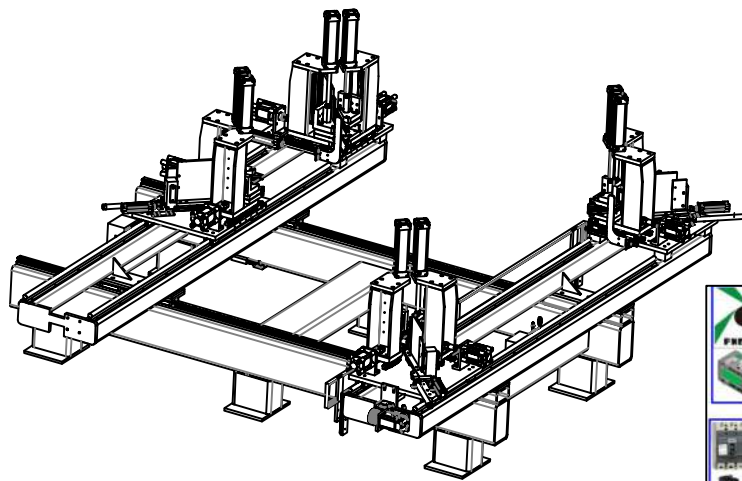
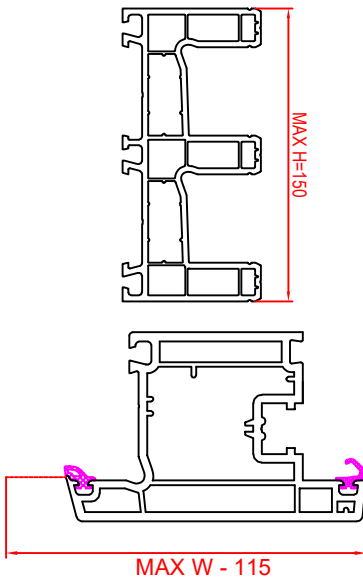
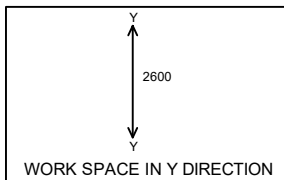
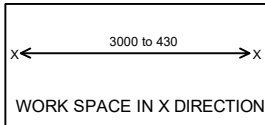

SINGLE-PHASE
230 volt

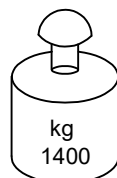

WEIGHT
kg
1400



6-7 BAR



AIR
CONSUMPTION
200 LPM

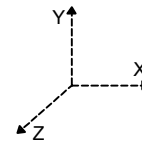

DIMENSIONS
L- 3900mm
H- 2000mm
W- 3500mm

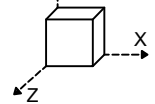

PACKAGING
L- 3950mm
H- 2050mm
W- 3550mm

TAALIN MACHINERY & ROBOTICS PVT. LTD.

931/931A, Winsten Park, Knowledge Park-V, Greater Noida West, U.P- 201308 (INDIA)

Web: <https://www.taalin.com>, Mail id: sales@taalin.com, Mob: 8882033535/8882910477

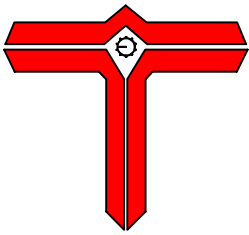

WTS S6LVVL SEAMLESS FOUR HEAD WELDING MACHINE

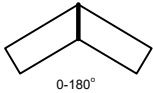

0-180°

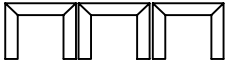

CORNER JOINT



BUTT JOINT

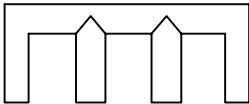

V- JOINT

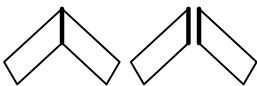

0.2mm & 2mm Welding

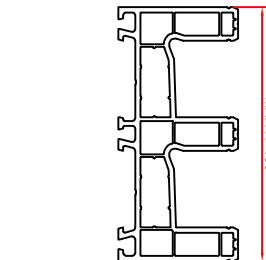

MAX H=150

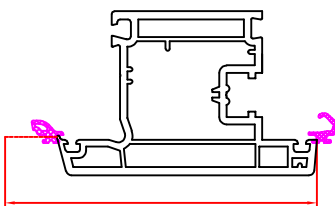

MAX W - 115

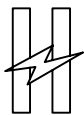
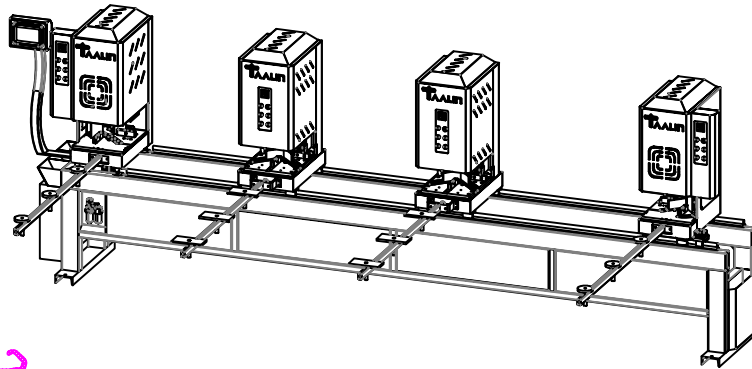

SINGLE-PHASE
230 volt

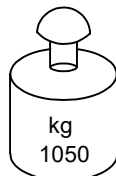

WEIGHT
kg
1050



6-7 BAR



AIR
CONSUMPTION
150 LPM

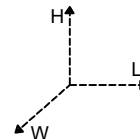

DIMENSIONS
L- 5190mm
H- 1590mm
W- 1120mm

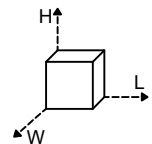

PACKAGING
L- 5240mm
H- 1640mm
W- 1170mm

TAALIN MACHINERY & ROBOTICS PVT. LTD.

931/931A, Winsten Park, Knowledge Park-V, Greater Noida West, U.P- 201308 (INDIA)
Web: <https://www.taalin.com>, Mail id: sales@taalin.com, Mob: 8882033535/8882910477

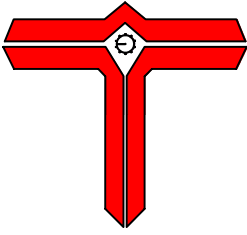

WTS S6 LVL SEAMLESS THREE HEAD WELDING MACHINE

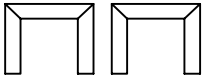
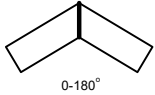

CORNER JOINT



BUTT JOINT

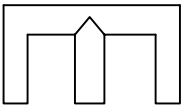

V- JOINT

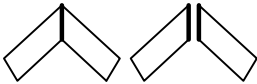

0.2mm & 2mm Welding

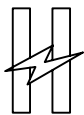
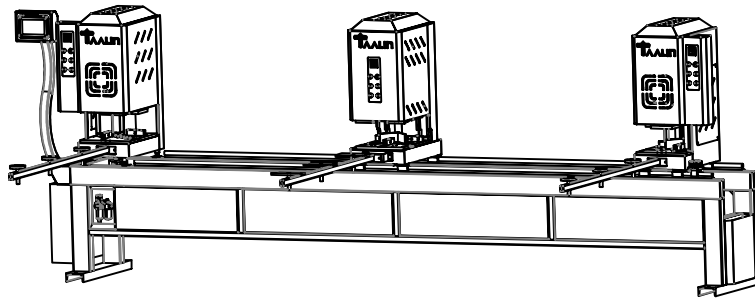
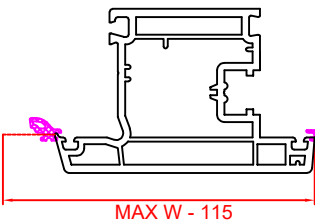
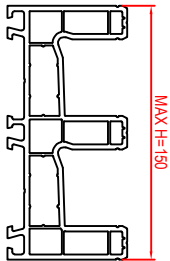

SINGLE-PHASE
230 volt

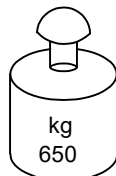

WEIGHT



6-7 BAR



AIR
CONSUMPTION
120 LPM

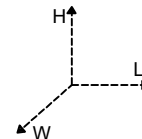

DIMENSIONS
L- 3700mm
H- 1410mm
W- 1285mm

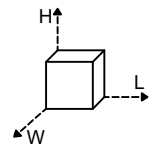

PACKAGING
L- 3750mm
H- 1460mm
W- 1335mm

TAALIN MACHINERY & ROBOTICS PVT. LTD.

931/931A, Winsten Park, Knowledge Park-V, Greater Noida West, U.P- 201308 (INDIA)
Web: <https://www.taalin.com>, Mail id: sales@taalin.com, Mob: 8882033535/8882910477

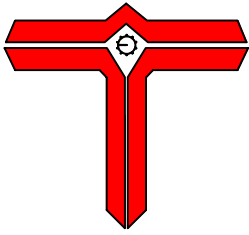

WDS SC7L NEAT SEAMLESS DOUBLE HEAD WELDING MACHINE

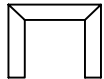
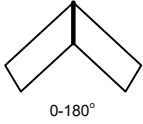

CORNER JOINT

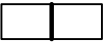

BUTT JOINT

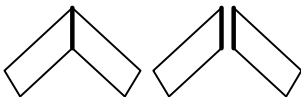

0.2mm & 2mm Welding

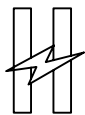
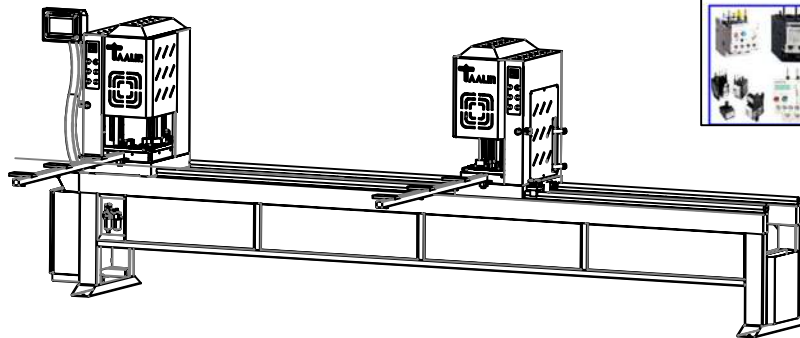
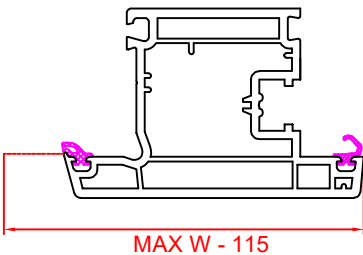
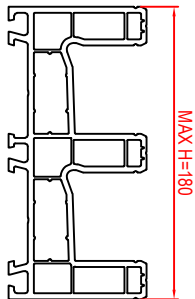

SINGLE-PHASE
230 volt

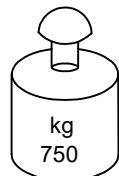

WEIGHT
kg
750



6-7 BAR



AIR
CONSUMPTION
120 LPM

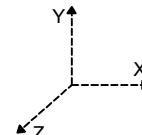

DIMENSIONS
L- 4250mm
H- 1600mm
W- 870mm

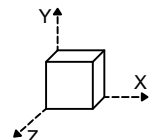

PACKAGING
L- 4350mm
H- 1700mm
W- 980mm

TAALIN MACHINERY & ROBOTICS PVT. LTD.

931/931A, Winsten Park, Knowledge Park-V, Greater Noida West, U.P- 201308 (INDIA)

Web: <https://www.taalin.com>, Mail id: sales@taalin.com, Mob: 8882033535/8882910477

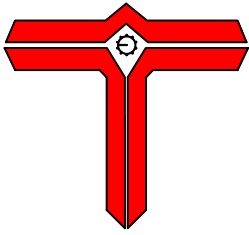

WDS S6L SEAMLESS DOUBLE HEAD WELDING MACHINE

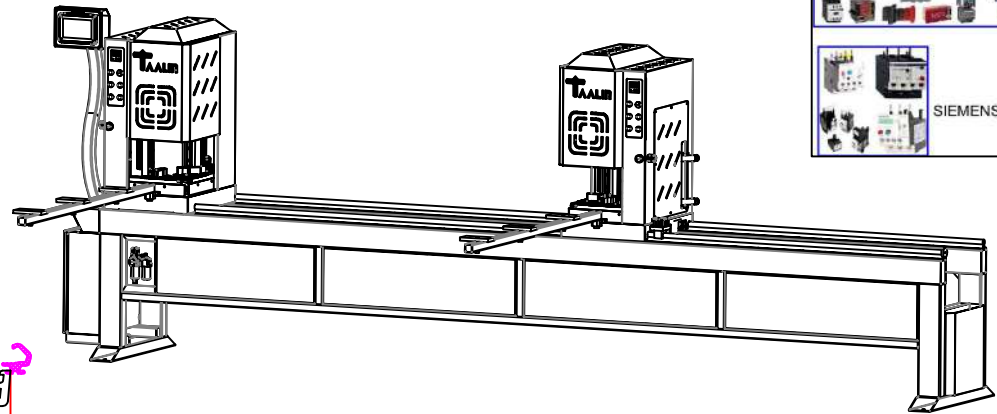
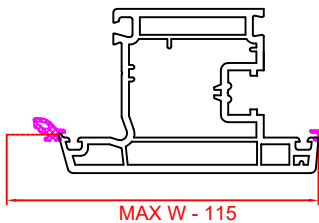
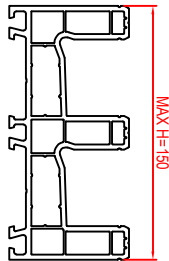
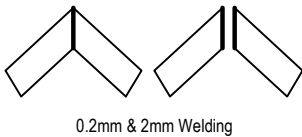
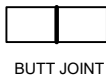
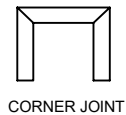
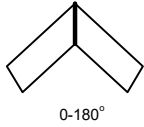

SINGLE-PHASE
230 volt

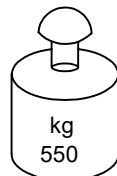

WEIGHT
kg
550



6-7 BAR



AIR
CONSUMPTION
120 LPM

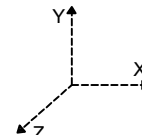

DIMENSIONS
L- 4370mm
H- 1760mm
W- 910mm

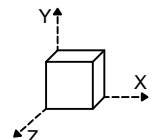

PACKAGING
L- 4420mm
H- 1810mm
W- 960mm

TAALIN MACHINERY & ROBOTICS PVT. LTD.

931/931A, Winsten Park, Knowledge Park-V, Greater Noida West, U.P- 201308 (INDIA)

Web: <https://www.taalin.com>, Mail id: sales@taalin.com, Mob: 8882033535/8882910477

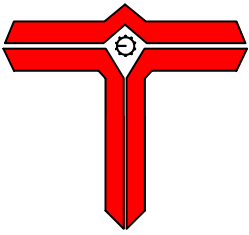

CCM - 10 AR CNC CORNER MACHINE-10TOOL

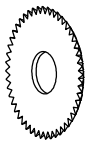
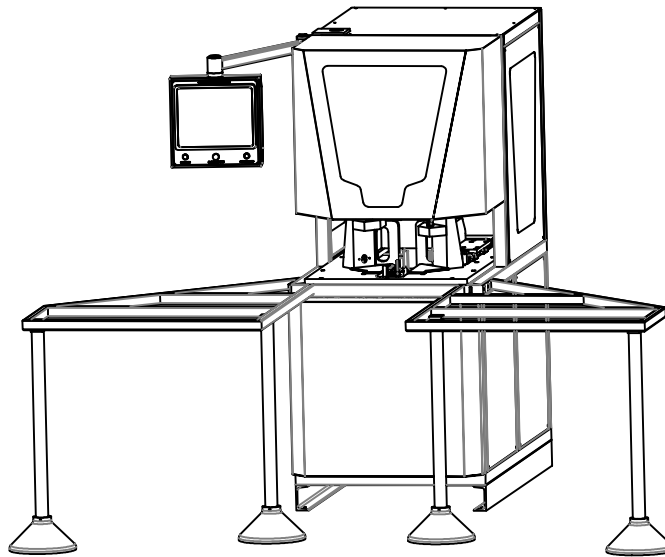
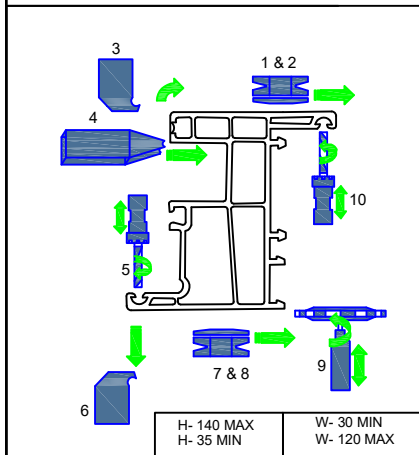

250 mm BLADE
2840 rpm

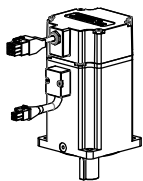

0.75KW & 1.0KW
Servo motors

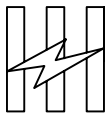

THREE-PHASE
400 volt

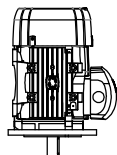

0.55 KW
2800 rpm

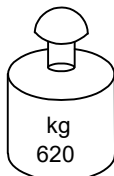

WEIGHT
kg
620



6-7 BAR



AIR
CONSUMPTION
120 L/M

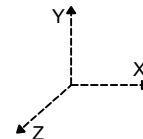

DIMENSIONS
L- 1220mm
H- 1750mm
W- 900mm

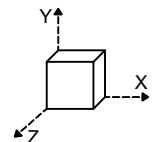

PACKAGING
L- 1300mm
H- 1850mm
W- 1000mm

TAALIN MACHINERY & ROBOTICS PVT. LTD.

931/931A, Winsten Park, Knowledge Park-V, Greater Noida West, U.P- 201308 (INDIA)
Web: <https://www.taalin.com>, Mail id: sales@taalin.com, Mob: 8882033535/8882910477

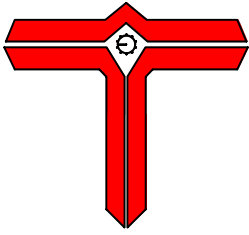

CCM - 7T CNC CORNER CLEANING-7TOOL

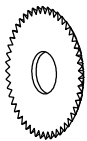
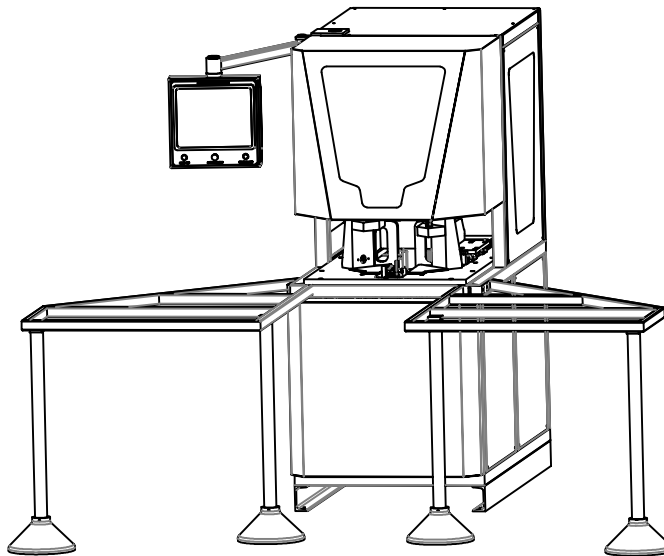
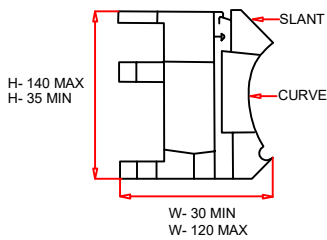
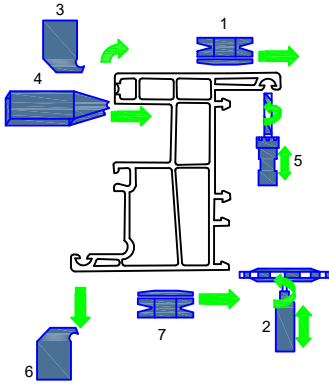

250 mm BLADE
2840 rpm

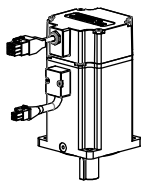

0.75KW & 1.0KW
Servo motors

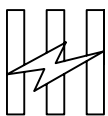

THREE-PHASE
400 volt

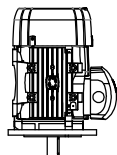

0.55 KW
2800 rpm

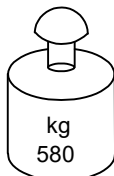

WEIGHT
kg
580



6-7 BAR



AIR
CONSUMPTION
120 L/M

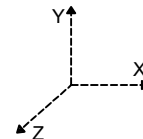

DIMENSIONS
L- 1220mm
H- 1750mm
W- 900mm

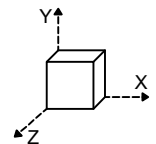

PACKAGING
L- 1280mm
H- 1825mm
W- 960mm

TAALIN MACHINERY & ROBOTICS PVT. LTD.

931/931A, Winsten Park, Knowledge Park-V, Greater Noida West, U.P- 201308 (INDIA)

Web: <https://www.taalin.com>, Mail id: sales@taalin.com, Mob: 8882033535/8882910477

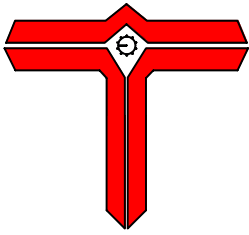

CCM - 5T CNC CORNER CLEANING-5TOOL

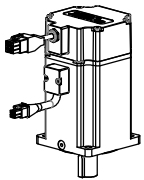
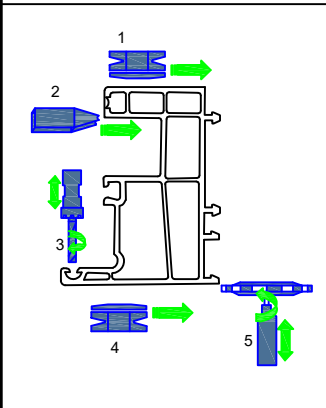
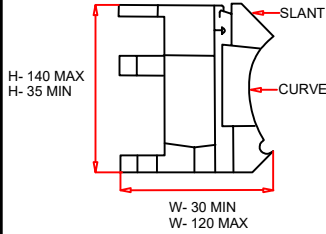

0.4 KW x2
Servo motor

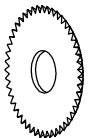

250 mm BLADE
2840 rpm

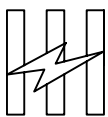

THREE-PHASE
400 volt

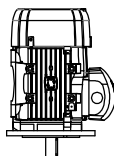

0.75 KW

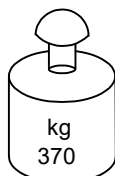

WEIGHT
kg
370



6-7 BAR



AIR
CONSUMPTION
100 LPM

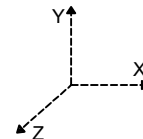

DIMENSIONS
L- 850mm
H- 1460mm
W- 1020mm

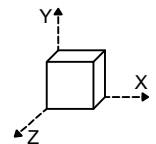

PACKAGING
L- 950mm
H- 1560mm
W- 1100mm



TAALIN MACHINERY & ROBOTICS PVT. LTD.

931/931A, Winsten Park, Knowledge Park-V, Greater Noida West, U.P- 201308 (INDIA)

Web: <https://www.taalin.com>, Mail id: sales@taalin.com, Mob: 8882033535/8882910477

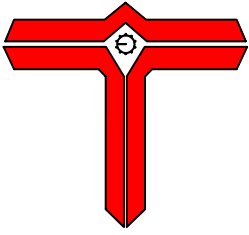

CCM - 3T

CCM CORNER CLEANING-3TOOL

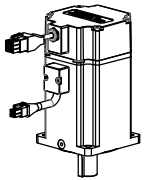
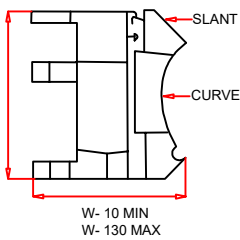
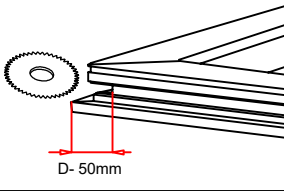
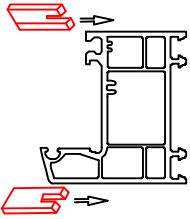

0.4 KW x2
Servo motor

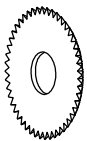

250 mm BLADE
2840 rpm

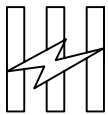
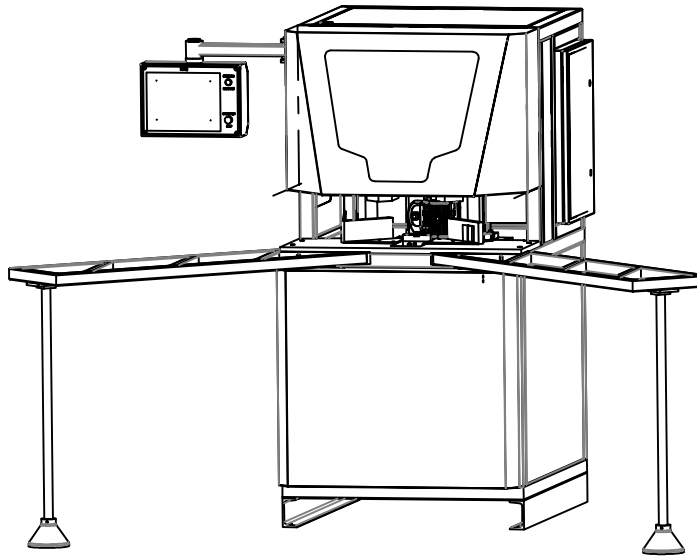

THREE-PHASE
400 volt

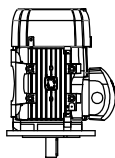

0.55 KW

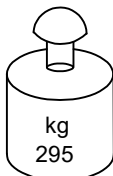

WEIGHT
kg
295



6-7 BAR



AIR
CONSUMPTION
30 L/M

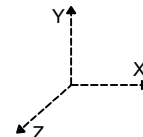

DIMENSIONS
L- 1040mm
H- 1560mm
W- 960mm

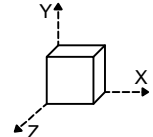

PACKAGING
L- 1090mm
H- 1610mm
W- 1010mm

TAALIN MACHINERY & ROBOTICS PVT. LTD.

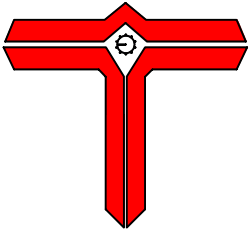

931/931A, Winsten Park, Knowledge Park-V, Greater Noida West, U.P- 201308 (INDIA)
Web: <https://www.taalin.com>, Mail id: sales@taalin.com, Mob: 8882033535/8882910477

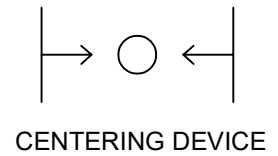
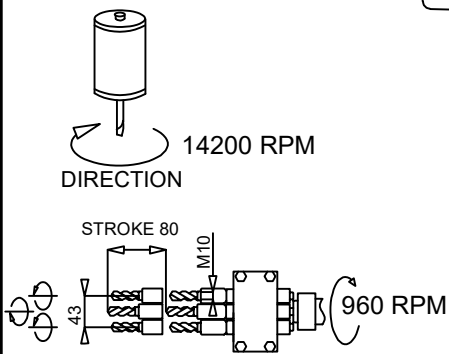
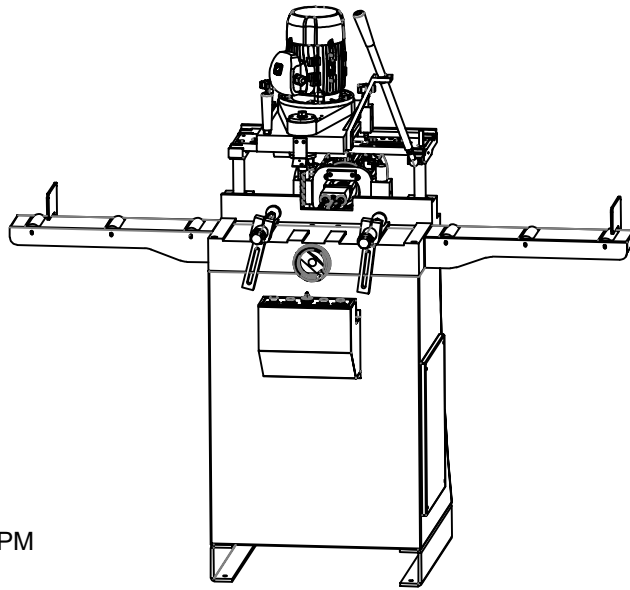
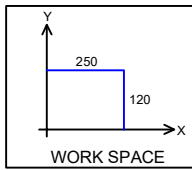
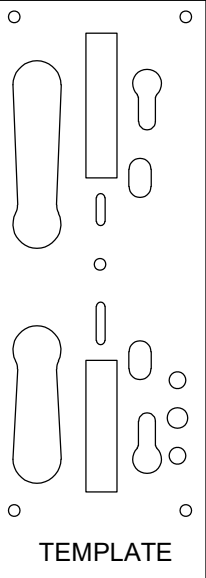
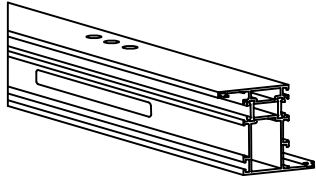

RAC/RAC 3D AL

SEMI COPY ROUTER WITH TRIPLE DRILL

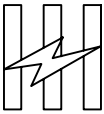
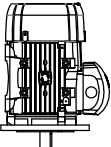
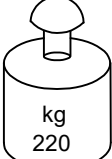

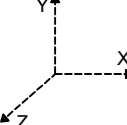
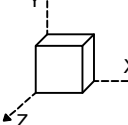
 THREE-PHASE 400 volt	 1.1 KW X 2 2800 rpm	 kg 220	 6-7 BAR	 AIR CONSUMPTION 30 L/M	 DIMENSIONS L- 695mm H- 1450mm W- 555mm	 PACKAGING L- 745mm H- 1500mm W- 605mm
--	---	--	--	--	--	---

TAALIN MACHINERY & ROBOTICS PVT. LTD.

931/931A, Winsten Park, Knowledge Park-V, Greater Noida West, U.P- 201308 (INDIA)
Web: <https://www.taalin.com>, Mail id: sales@taalin.com, Mob: 8882033535/8882910477

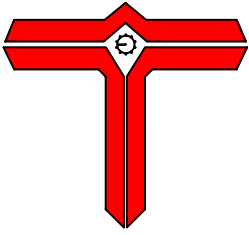

RC AL / RC 3D

COPY ROUTER WITH TRIPPLE DRILLING

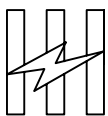
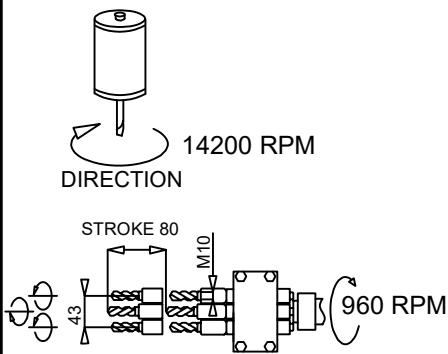
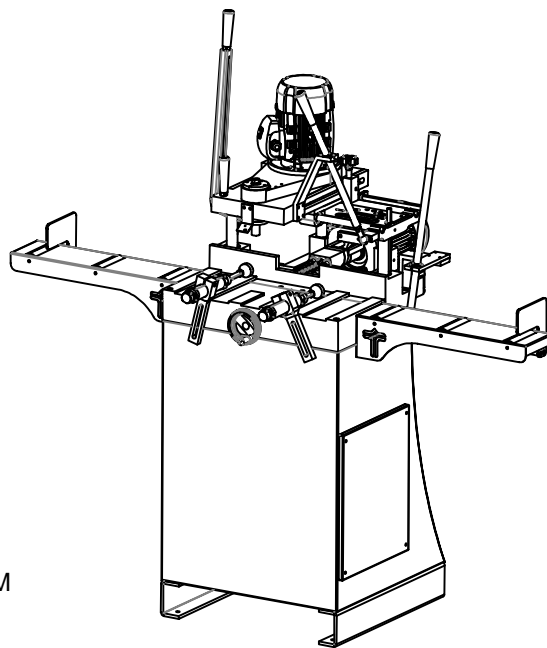
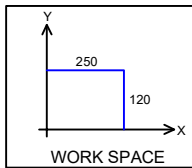
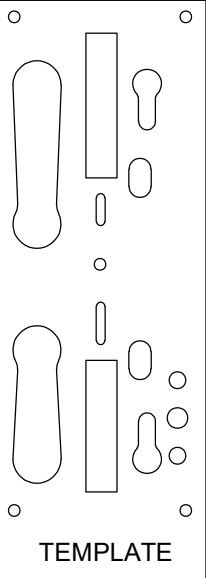
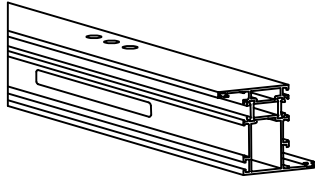

THREE-PHASE
400 volt

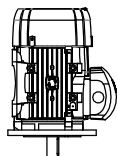

1.1 KW X 2
2800 rpm

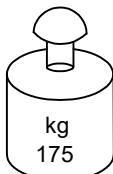

WEIGHT



6-7 BAR



AIR
CONSUMPTION
30 L/M

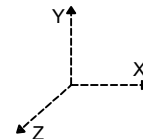

DIMENSIONS
L- 695mm
H- 1450mm
W- 555mm

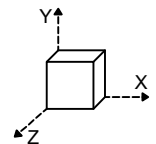

PACKAGING
L- 745mm
H- 1500mm
W- 605mm

TAALIN MACHINERY & ROBOTICS PVT. LTD.

931/931A, Winsten Park, Knowledge Park-V, Greater Noida West, U.P- 201308 (INDIA)

Web: <https://www.taalin.com>, Mail id: sales@taalin.com, Mob: 8882033535/8882910477

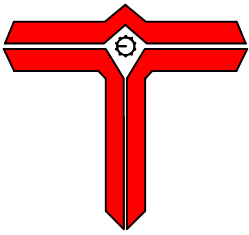

RC - AL COPY ROUTER

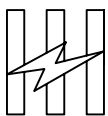
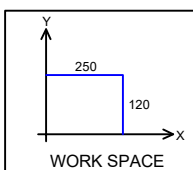
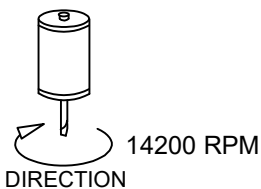
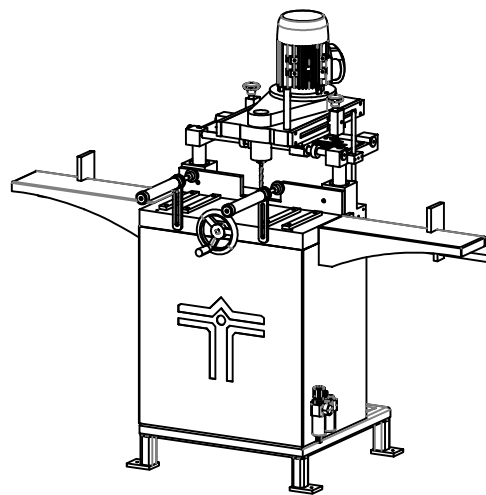
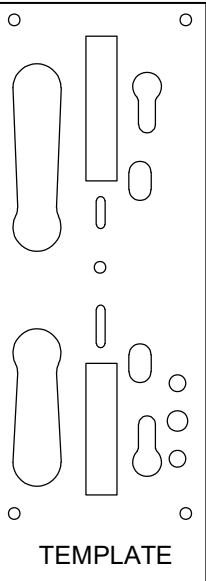
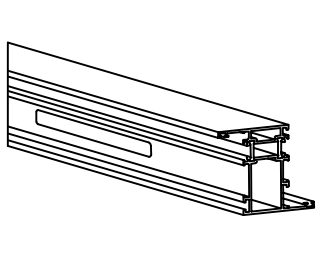

THREE-PHASE
400 volt

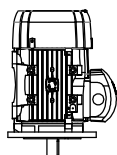

1.1 KW
2800 rpm

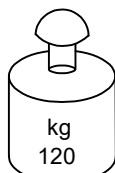

WEIGHT



6-7 BAR



AIR
CONSUMPTION
20 L/M

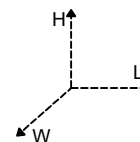

DIMENSIONS
L- 695mm
H- 1450mm
W- 555mm

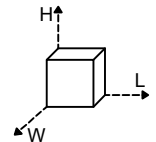

PACKAGING
L- 745mm
H- 1500mm
W- 605mm

TAALIN MACHINERY & ROBOTICS PVT. LTD.

931/931A, Winsten Park, Knowledge Park-V, Greater Noida West, U.P- 201308 (INDIA)
Web: <https://www.taalin.com>, Mail id: sales@taalin.com, Mob: 8882033535/8882910477

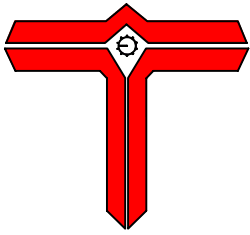

RWS 3S

WATER DRAIN SLOT WITH 3 SPINDLE

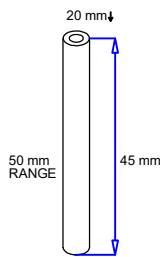
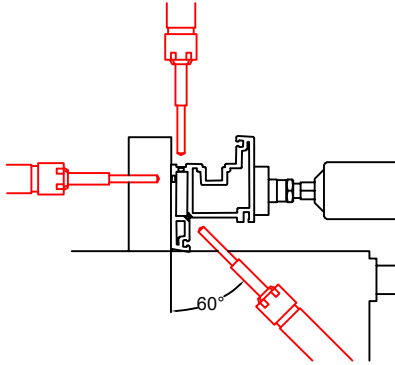

SPINDLE



8x50x80



220 VOLT

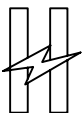

SINGLE-PHASE
230 volt



3/3 X 500w
27000 rpm

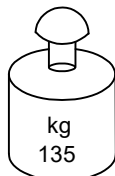

WEIGHT
135



6-7 BAR



AIR
CONSUMPTION
15 L/M

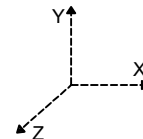

DIMENSIONS
L- 700mm
H- 1150mm
W- 510mm

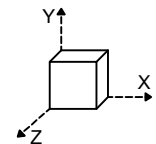

PACKAGING
L- 750mm
H- 1200mm
W- 560mm

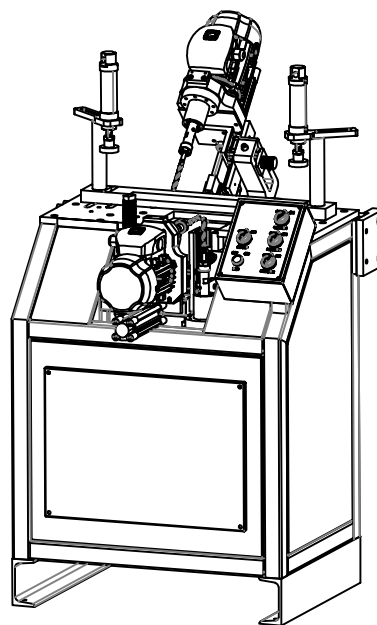

TAALIN MACHINERY & ROBOTICS PVT. LTD.

931/931A, Winsten Park, Knowledge Park-V, Greater Noida West, U.P- 201308 (INDIA)

Web: <https://www.taalin.com>, Mail id: sales@taalin.com, Mob: 8882033535/8882910477

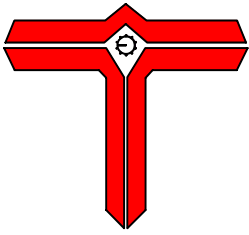

SGB 100A UNIVERSAL GLAZING BEAD SAW

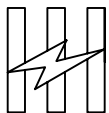
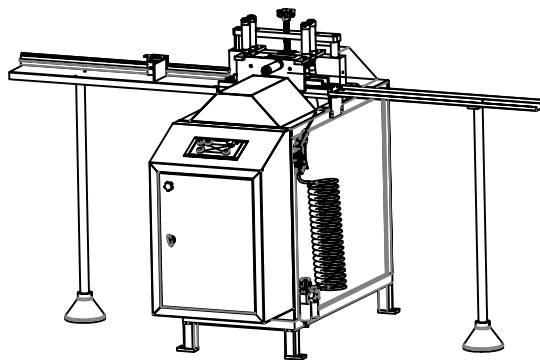
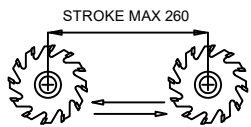
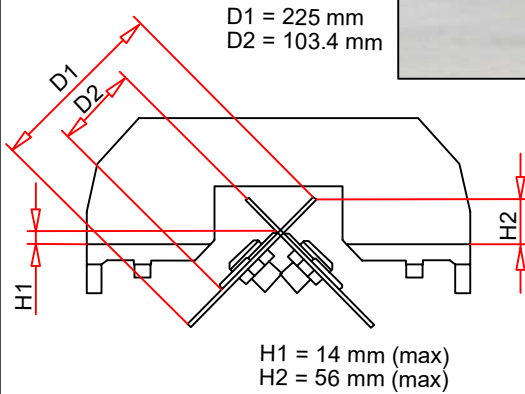
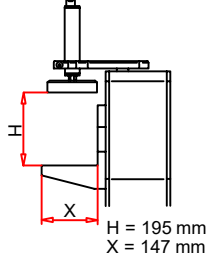

THREE-PHASE
400 volt

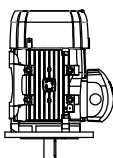

0.55 KW x2
2800 rpm

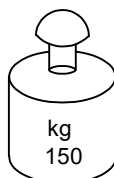

WEIGHT



6-7 BAR



AIR
CONSUMPTION
60 LPM

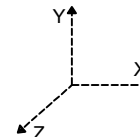

DIMENSIONS
L- 1190mm
H- 1070mm
W- 570mm

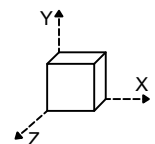

PACKAGING
L- 1240mm
H- 1120mm
W- 620mm

TAALIN MACHINERY & ROBOTICS PVT. LTD.

931/931A, Winsten Park, Knowledge Park-V, Greater Noida West, U.P.- 201308 (INDIA)
Web: <https://www.taalin.com>, Mail id: sales@taalin.com, Mob: 8882033535/8882910477

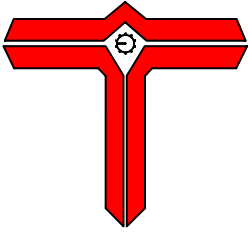

ME 5A/ME 5A - AL/ UPVC AUTOMATIC END MILLING MACHINE

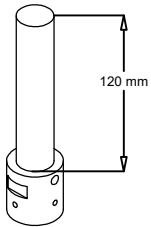
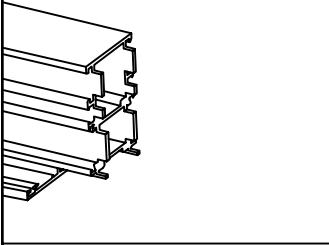

3 X QUICK CHANGE
CUTTER SLEEVE

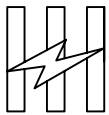
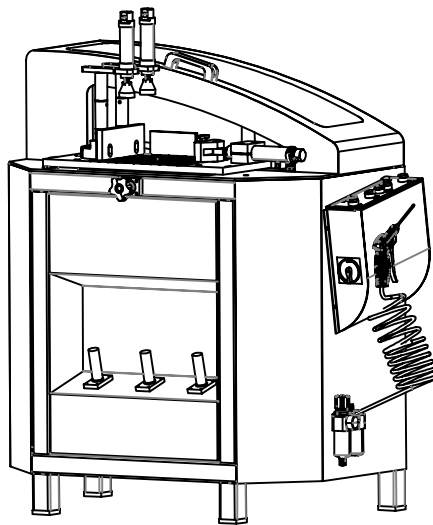
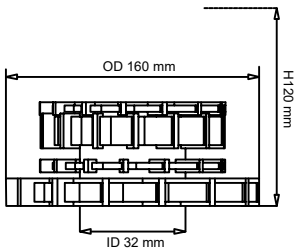
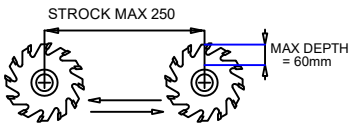

THREE-PHASE
WITH NEUTRAL
400 volts

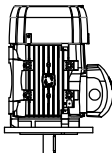

1.5 KW
2800 rpm

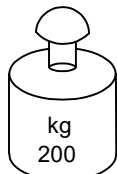

WEIGHT
kg
200



6-7 BAR



AIR
CONSUMPTION
5 L/M

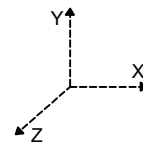

DIMENSIONS
L - 830mm
H - 1050mm
W - 540+400mm

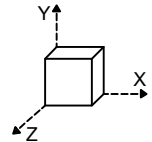

PACKAGING
L- 880mm
H- 1100mm
W- 590mm

TAALIN MACHINERY & ROBOTICS PVT. LTD.

931/931A, Winsten Park, Knowledge Park-V, Greater Noida West, U.P- 201308 (INDIA)
Web: <https://www.taalin.com>, Mail id: sales@taalin.com, Mob: 8882033535/8882910477

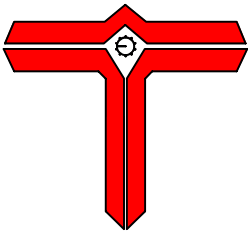

SVC 2A8
AUTOMATIC V CUT SAW

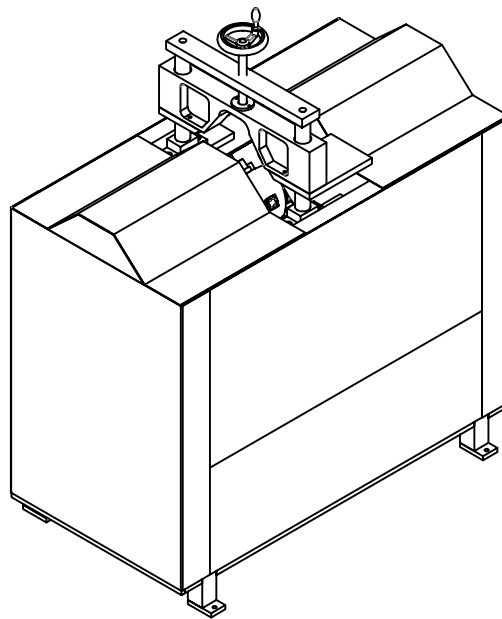
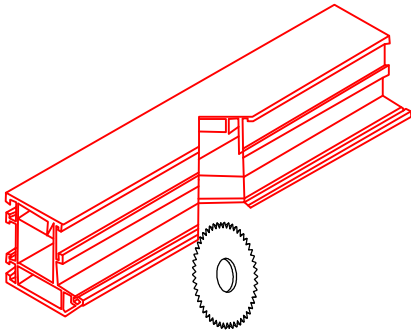

380 VOLT

STROKE MAX 260

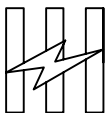
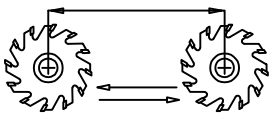

THREE-PHASE
400 volt

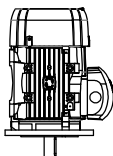

0.55KW X 2
2800 rpm

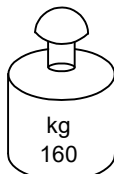

WEIGHT
kg
160



6-7 BAR



AIR
CONSUMPTION
60 LPM

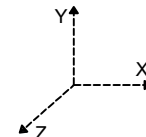

DIMENSIONS
L- 1590mm
H- 1280mm
W- 810mm

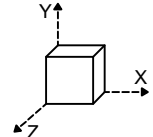

PACKAGING
L- 1640mm
H- 1330mm
W- 860mm

TAALIN MACHINERY & ROBOTICS PVT. LTD.

931/931A, Winsten Park, Knowledge Park-V, Greater Noida West, U.P- 201308 (INDIA)

Web: <https://www.taalin.com>, Mail id: sales@taalin.com, Mob: 8882033535/8882910477

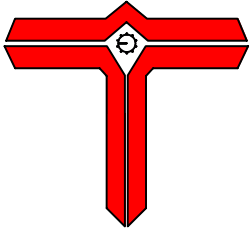

SCC 20A

CNC DIGITAL MOTOR BODY CUTTING

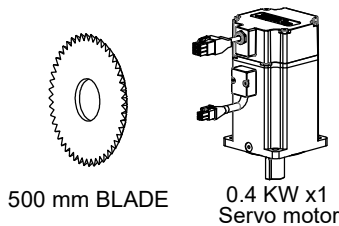
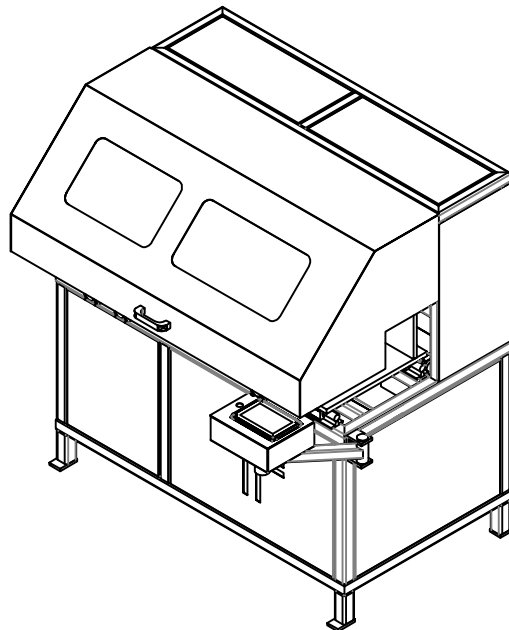
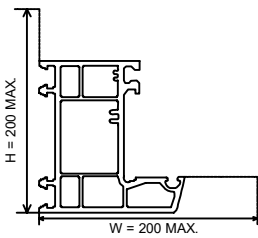
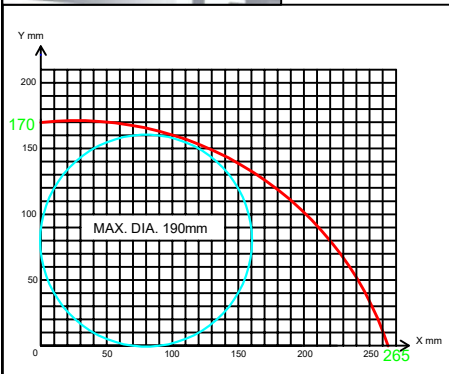

500 mm BLADE

0.4 KW x1 Servo motor

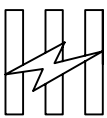

THREE-PHASE
400 volt

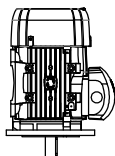

1.5 KW
2800 rpm

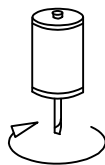

DIRECTION

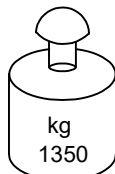

WEIGHT
kg
1350



6-8 BAR



AIR CONSUMPTION
100 LPM

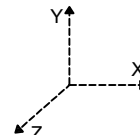

DIMENSIONS
L - 1420mm
H - 1460mm
W - 1140mm

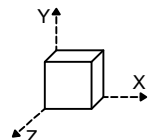

PACKAGING
L - 1500mm
H - 1550mm
W - 1220mm

TAALIN MACHINERY & ROBOTICS PVT. LTD.

931/931A, Winsten Park, Knowledge Park-V, Greater Noida West, U.P- 201308 (INDIA)

Web: <https://www.taalin.com>, Mail id: sales@taalin.com, Mob: 8882033535/8882910477

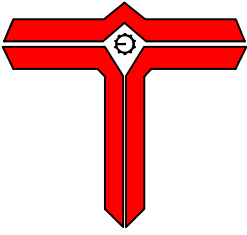

SCC 18A CNC DIGITAL CLEAT MACHINE

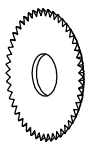
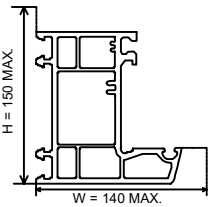
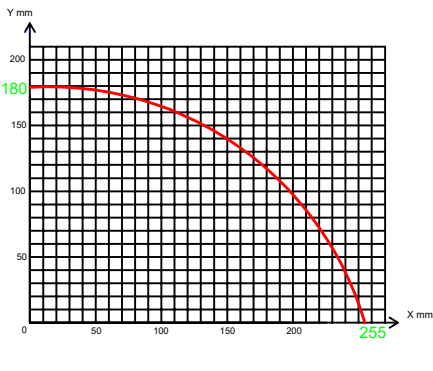

420/450 mm BLADE

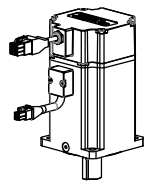

0.4 KW x1 Servo motor

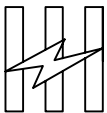
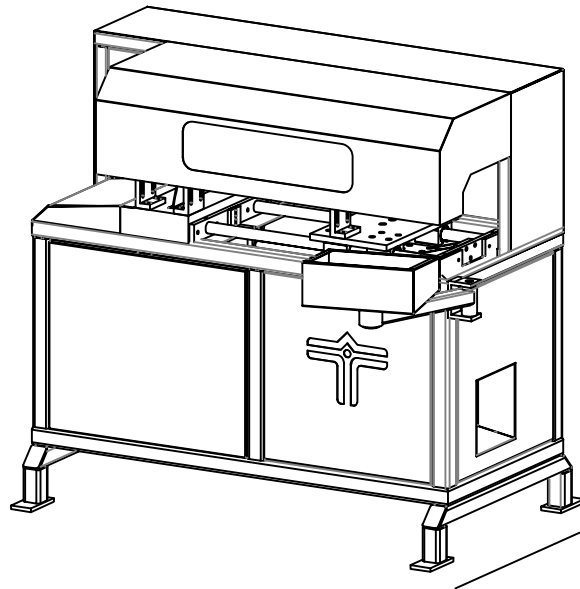

THREE-PHASE
400 volt

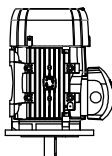

1.5 KW
2800 rpm

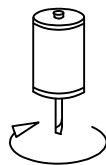

DIRECTION

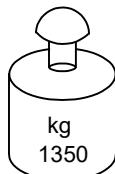

WEIGHT
kg
1350



6-8 BAR



AIR CONSUMPTION
100 LPM

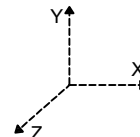

DIMENSIONS
L - 1320mm
H - 1200mm
W - 1100mm

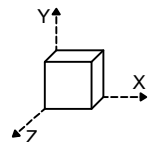

PACKAGING
L - 1400mm
H - 1300mm
W - 1200mm

TAALIN MACHINERY & ROBOTICS PVT. LTD.

931/931A, Winsten Park, Knowledge Park-V, Greater Noida West, U.P- 201308 (INDIA)
Web: <https://www.taalin.com>, Mail id: sales@taalin.com, Mob: 8882033535/8882910477

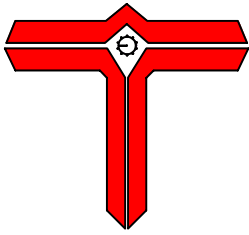

BUA - 300 ARC BENDING MACHINE

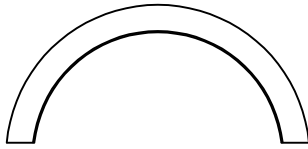

MAXIMUM ARC
RADIUS
1250 mm



MINIMUM ARC
RADIUS
450 mm

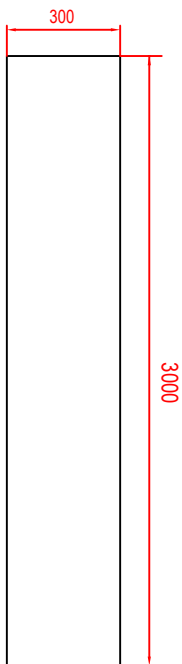

OIL TANK
DIMENSIONS

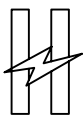
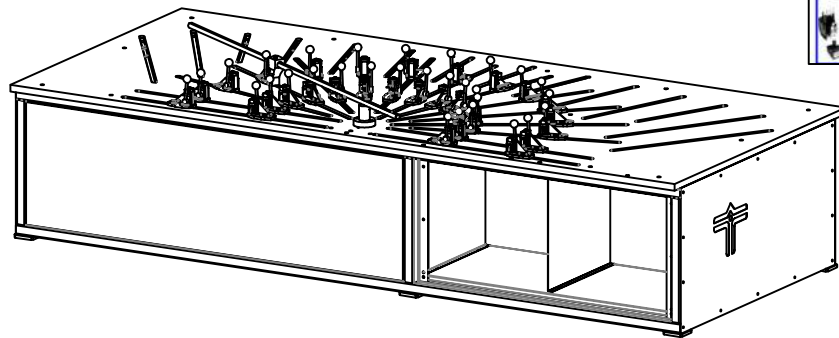

SINGLE-PHASE
8KW

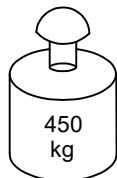

WEIGHT
450 kg

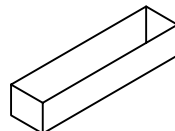

TANK CAPACITY
225 LITERS

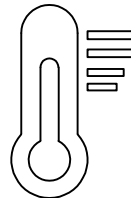

TEMPERATURE
90° C

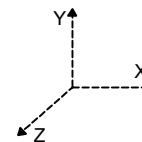

DIMENSIONS
L- 1820mm
H- 600mm
W- 1150mm

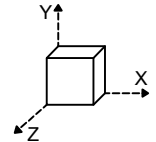

PACKAGING
L- 1900mm
H- 700mm
W- 1250mm

TAALIN MACHINERY & ROBOTICS PVT. LTD.

931/931A, Winsten Park, Knowledge Park-V, Greater Noida West, U.P- 201308 (INDIA)
Web: <https://www.taalin.com>, Mail id: sales@taalin.com, Mob: 8882033535/8882910477

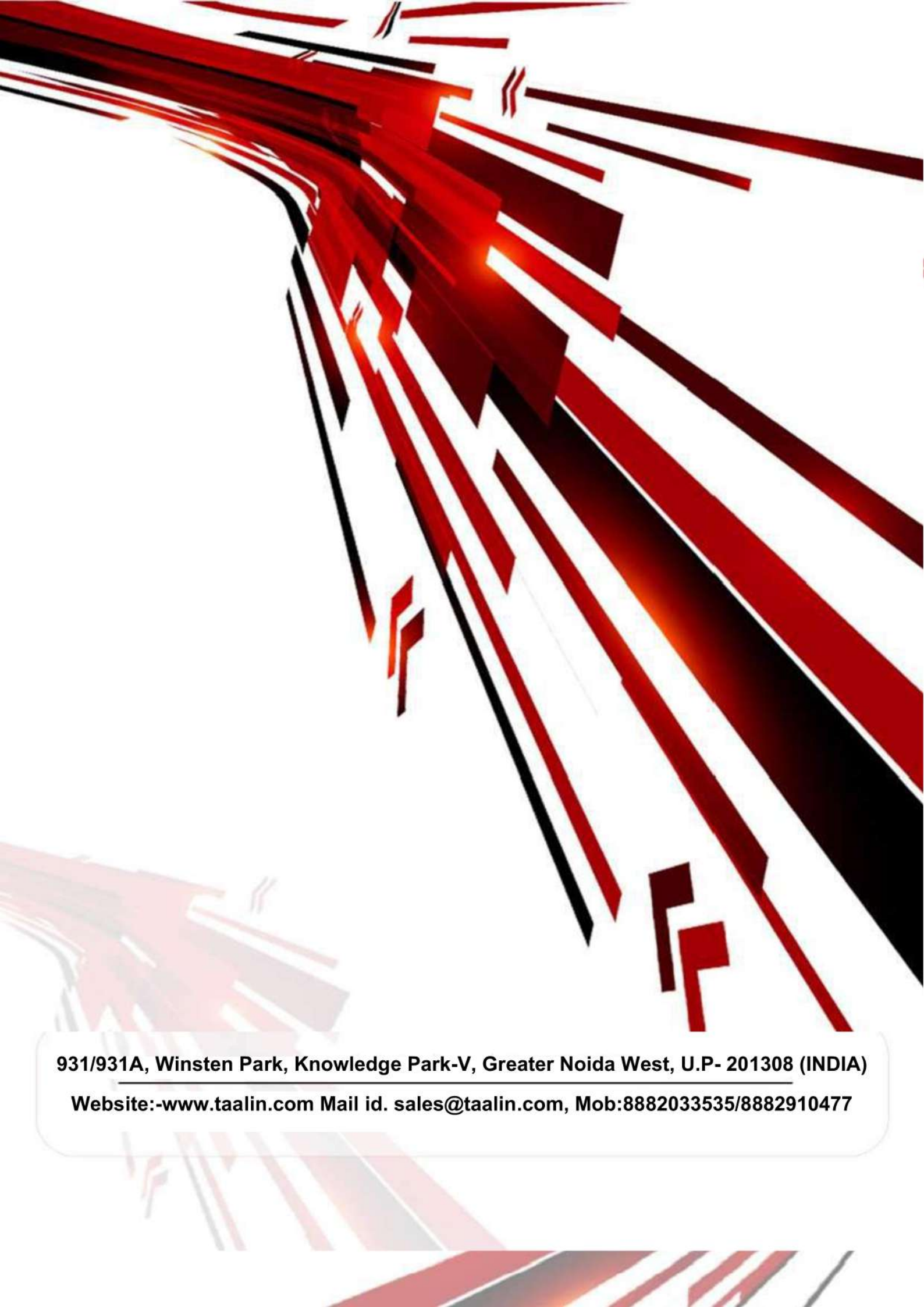

931/931A, Winsten Park, Knowledge Park-V, Greater Noida West, U.P- 201308 (INDIA)

Website:-www.taalin.com Mail id. sales@taalin.com, Mob:8882033535/8882910477