



PROMAX[®]
uPVC Profiles

ECO-CARE Building Innovations Pvt. Ltd.

Regd. Office: 4th Floor, VEDA's PRIME HOUSE Plot No. 19,
Jayabheri Enclave, Gachibowli, Hyderabad - 500 032.

Works: Near Chillakallu Tollgate, Off NH-65, Bhimavaram (V),
Vatsavai (M), NTR (D), Andhra Pradesh - 521 178.

Ph: 800 888 6345 / 970 506 8999
Website: www.promaxprofiles.com

Godown: FXGQ+J45, Dhanwapur Village, Sector 104,
Gurugram, Haryana 122006. Ph: 915 469 1090



**ONE OF THE BIGGEST uPVC PROFILES
MANUFACTURERS
IN INDIA**



PROMAX Profiles offers world-class uPVC profiles to its customers by giving superior protection to their homes and offices. The product possesses an inherent ability to conserve energy throughout its lifetime right from its raw material stage to the end use stage.

The energy efficiency property gives them Green & Eco-friendly recognition. Doors and Windows made with PROMAX uPVC Profiles are available in various sizes, shapes, and colours. Designed to withstand the Indian climate, the product complies with worldwide norms and safety & quality parameters. When passion meets excellence, unbelievable things come into existence. Driven by such relentless spirit, a group of a highly qualified and like-minded proficient group of people have established a manufacturing facility focusing on innovative profiles for uPVC Doors & Windows market.

Why PROMAX uPVC

Team of Experts: We are a group of highly qualified and proficient group of people who have established a manufacturing facility focusing on innovative profiles for uPVC Doors & Windows.

Our Approach: The flexible approach to client needs means providing customized solutions to almost any task we are set for.

On Time Delivery: We are highly committed to on-time deliveries.



ADVANTAGES

- Fire Resistance
- Noise Reduction
- Energy Saving
- Waterproof
- Durability
- Wind Resistance
- Safety
- UV Resistance
- Termite Proof
- Eco-friendly

CASEMENT SERIES

PM-2001 : C/W OF

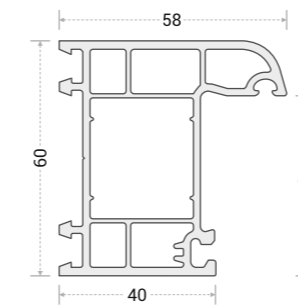

WEIGHT :- 0.975 Kg/M

Reinforcement

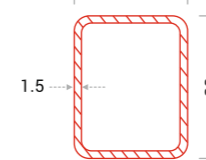

PM-2301 : C/W TRANSOM

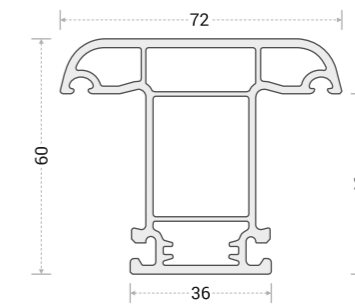

WEIGHT :- 1.000 Kg/M

Reinforcement

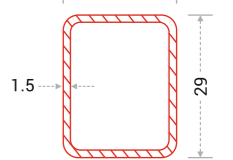

PM-2101 : C/W-SASH

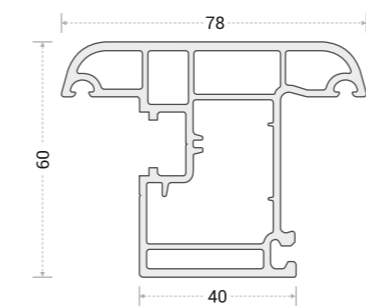

WEIGHT :- 1.140 Kg/M

Reinforcement

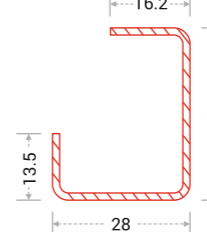

PM-2302 : C/W-Z-TRANSOM

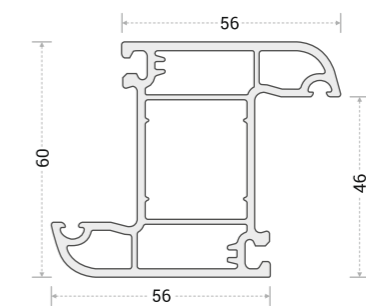

WEIGHT :- 1.050 Kg/M

Reinforcement

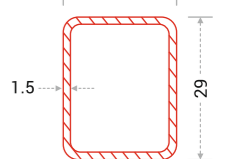

PM-2102 : C/D-T-SASH

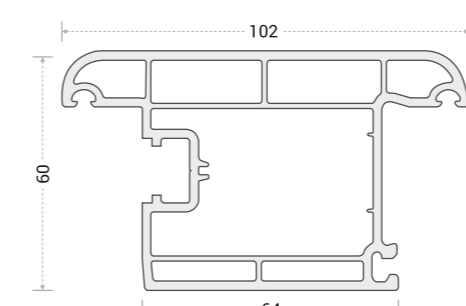

WEIGHT :- 1.590 Kg/M

Reinforcement

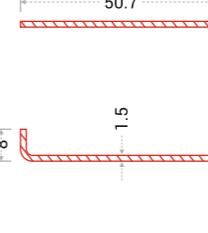

PM-2002 : C/D OF

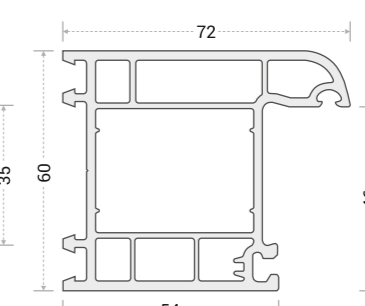

WEIGHT :- 1.280 Kg/M

Reinforcement

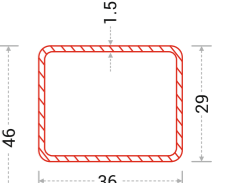

PM-2201 : CW BEAD

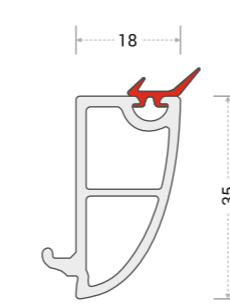

WEIGHT :- 0.350 Kg/M

PM-2103 : C/D Z-SASH

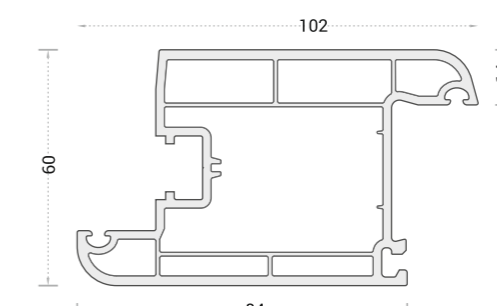

WEIGHT :- 1.490 Kg/M

Reinforcement



VILLA SERIES

PM-4001 VILLA FRAME

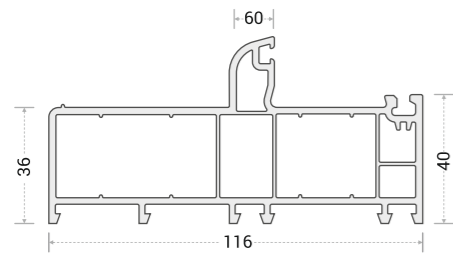

Reinforcement

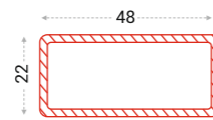

Reinforcement

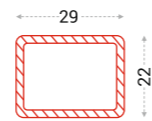

WEIGHT :- 1.405 Kg/M

PM-4301 VILLA MULLION

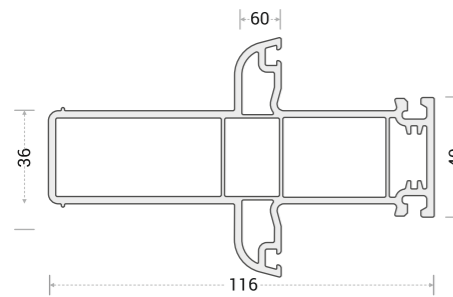

Reinforcement

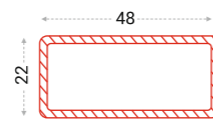

Reinforcement

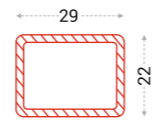

WEIGHT :- 1.444 Kg/M

PM-3101 C/W SMALL SASH

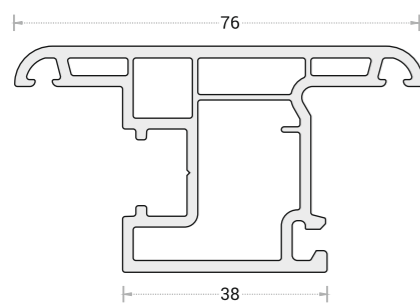

Reinforcement

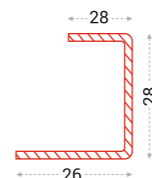

PM-2101 : C/W-SASH

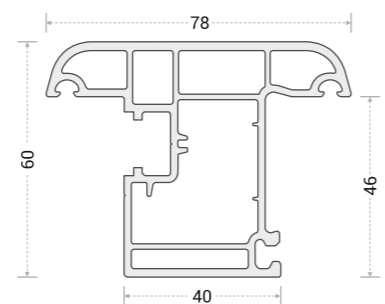

Reinforcement

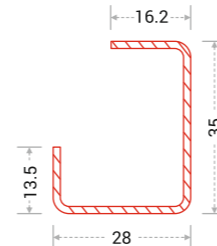

WEIGHT :- 0.891 Kg/M

WEIGHT :- 1.140 Kg/M

PM-2201 : CW BEAD

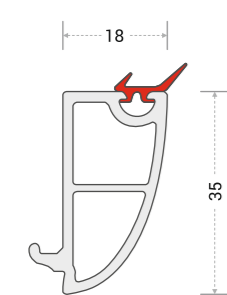

WEIGHT :- 0.350 Kg/M

PM-1201 : S/W BEAD

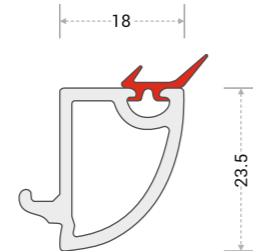

WEIGHT :- 0.230 Kg/M

PM-1202 : S/W BEAD 18MM

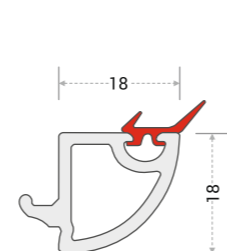

WEIGHT :- 0.235 Kg/M

SLIDING SERIES

PM-1003 : S/W-3 TRACK FRAME

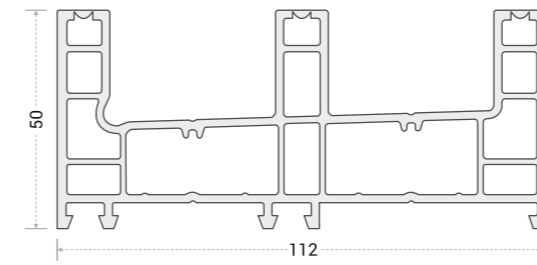

Reinforcement

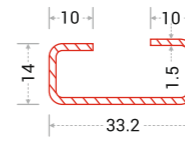

WEIGHT :- 1.570 Kg/M

PM-1001 : 2 TRACK FRAME

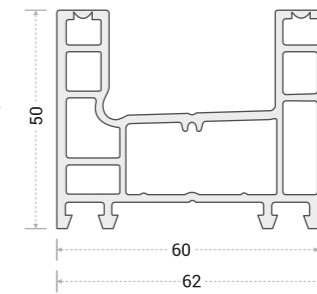

Reinforcement

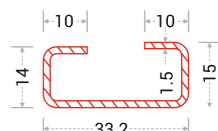

WEIGHT :- 0.972 Kg/M

PM-1002 : 2.5 TRACK FRAME

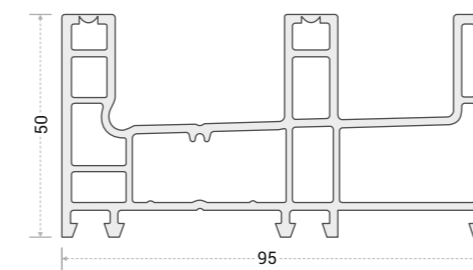

Reinforcement

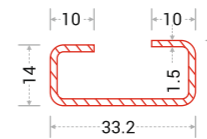

WEIGHT :- 1.400 Kg/M

PM-1101 : S/W SASH

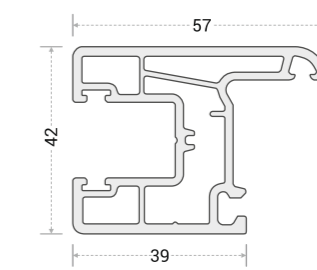

Reinforcement

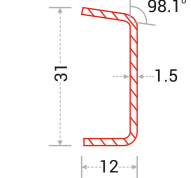

WEIGHT :- 0.825 Kg/M

PM-1102 : S/W SUPER SASH

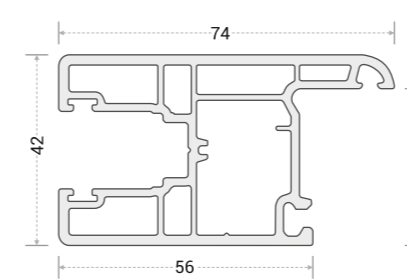

Reinforcement

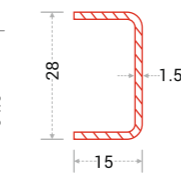

WEIGHT :- 0.972 Kg/M

PM-1103 : S/D SASH

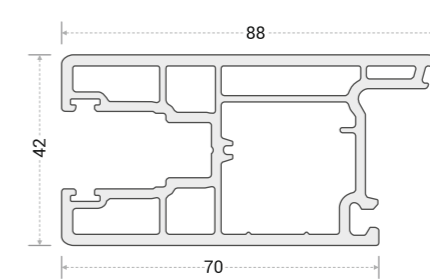

Reinforcement

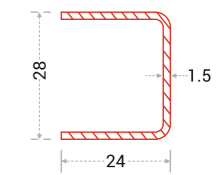

WEIGHT :- 1.290 Kg/M

PM-3002 : SMALL CASEMENT SASH MULLION

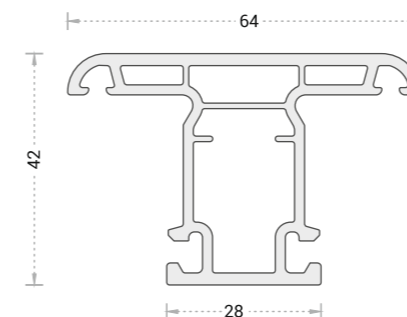

Reinforcement

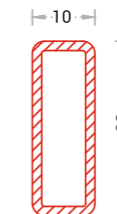

WEIGHT :- 0.740 Kg/M

PM-1201 : S/W BEAD

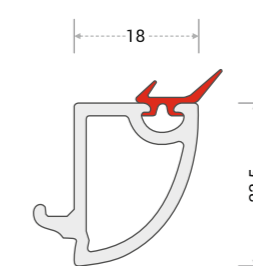

WEIGHT :- 0.230 Kg/M

PM-1203 : S/W DG BEAD

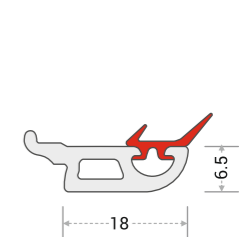

WEIGHT :- 0.143 Kg/M

SLIDING SERIES

PM-1302 : S/W BIG INTER LOCK

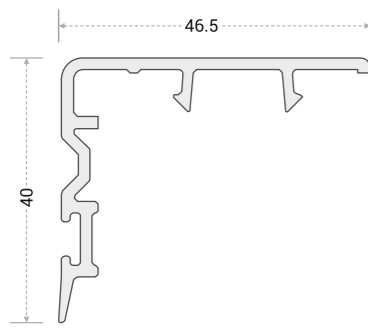

WEIGHT :- 0.339 Kg/M

PM-1301 : S/W INTER LOCK

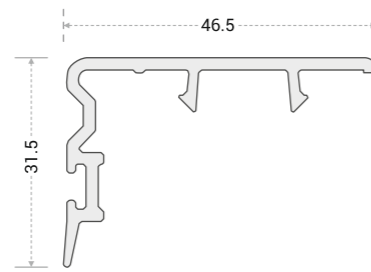

WEIGHT :- 0.299 Kg/M

PM-1303 : S/D INTER LOCK

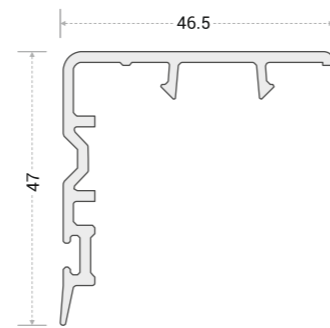

WEIGHT :- 0.366 Kg/M

PM-1205 : MESH MULLION

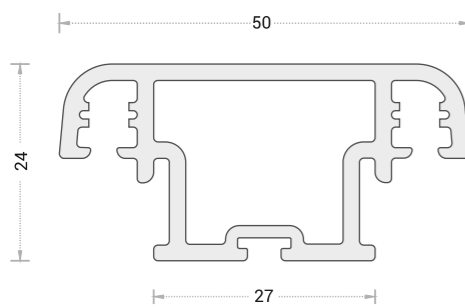

WEIGHT :- 0.500 Kg/M

PM-1204 : S/W-MESH

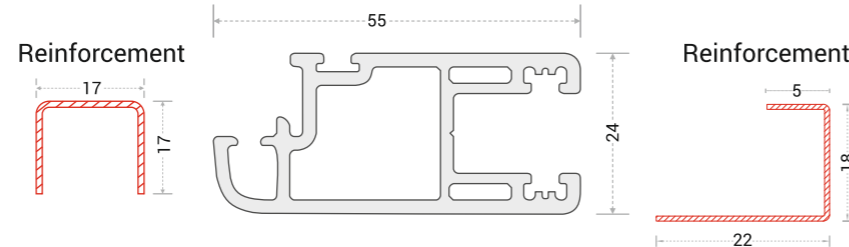

WEIGHT :- 0.562 Kg/M

ECO CASEMENT SERIES

PM-3001 : SMALL CASEMENT FRAME

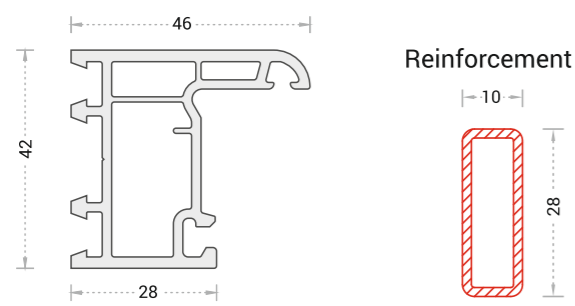

WEIGHT :- 0.580 Kg/M

PM-3002 : SMALL C/S MULLION

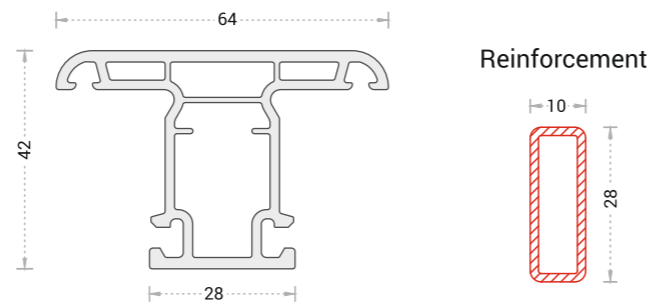

WEIGHT :- 0.740 Kg/M

PM-3101 C/W SMALL SASH

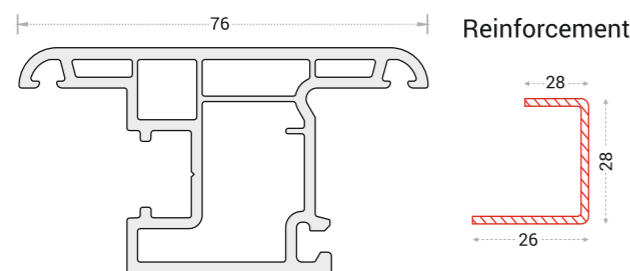

WEIGHT :- 0.891 Kg/M

PM-1201 : S/W BEAD

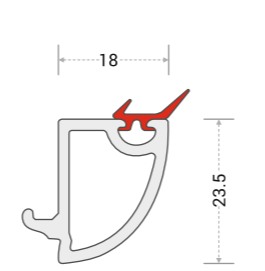

WEIGHT :- 0.270 Kg/M

ECO SLIDING SERIES

PM-1005 : 3 TRACK FRAME 94MM

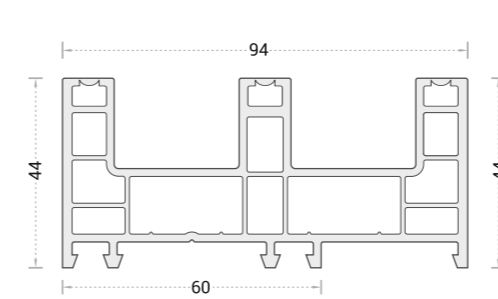

WEIGHT :- 1.335 Kg/M

PM-1006 : 2 TRACK FRAME 53MM

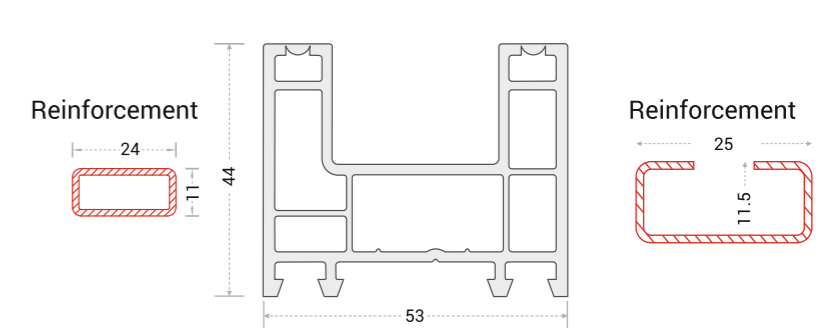

WEIGHT :- 0.826 Kg/M

PM-1004 : 2.5 TRACK 80MM

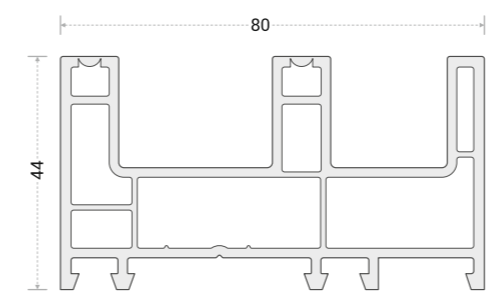

WEIGHT :- 1.100 Kg/M

PM-1104 : S/W-SASH(55)

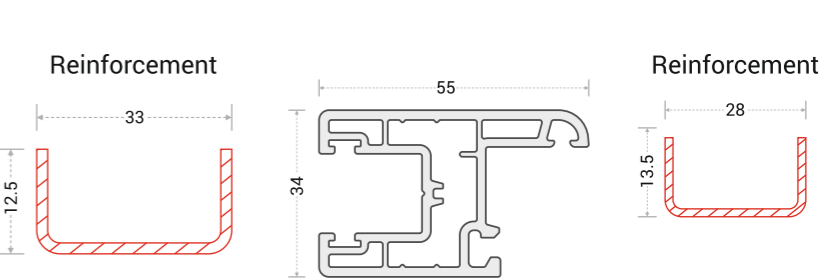

WEIGHT :- 0.700 Kg/M

PM-1106 : SUPER SASH 80 SERIES

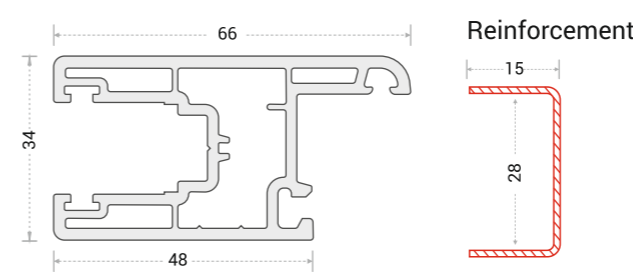

WEIGHT :- 0.862 Kg/M

PM-1105 : S/D SASH 80 SERIES

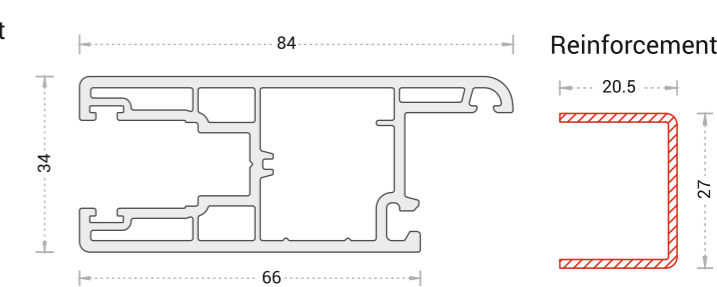

WEIGHT :- 1.006 Kg/M

PM-1304 : S/W INTER LOCK

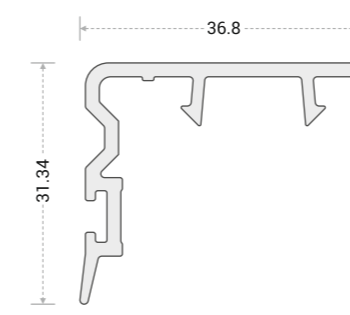

WEIGHT :- 0.230 Kg/M

PM-1305 : S/D INTERLOCK

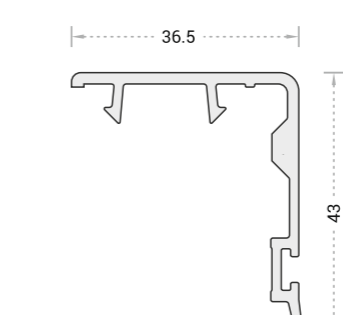

WEIGHT :- 0.260 Kg/M

PM-1202 : S/W BEAD 18MM

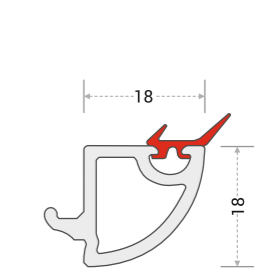

WEIGHT :- 0.235 Kg/M

ECO SLIDING SERIES

PM-1205 : MESH MULLION

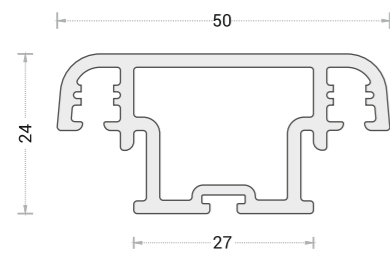

WEIGHT :- 0.500 Kg/M

Reinforcement

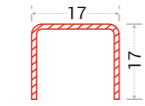

PM-1204 S/W MESH

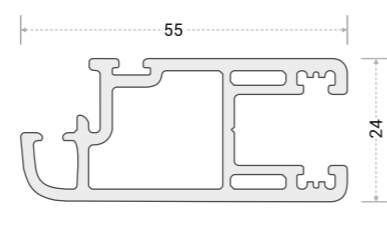

WEIGHT :- 0.562 Kg/M

Reinforcement

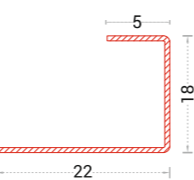

AUXILIARY PROFILES

PM-9003 : PANEL BOARD

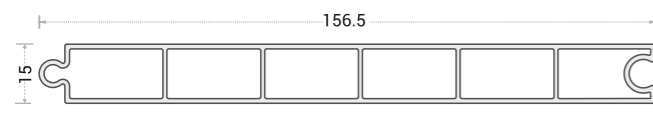

WEIGHT :- 0.720 Kg/M

PM-9009 : GEORGIAN BAR

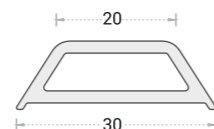

WEIGHT :- 0.165 Kg/M

PM-9001 : T COUPLER

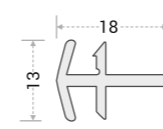

WEIGHT :- 0.110 Kg/M

PM-9007 : LOUVER BLADE

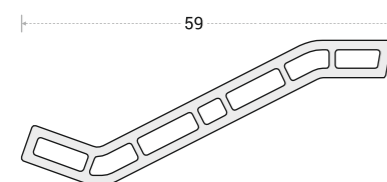

WEIGHT :- 0.330 Kg/M

PM-9008 : LOUVER BEAD

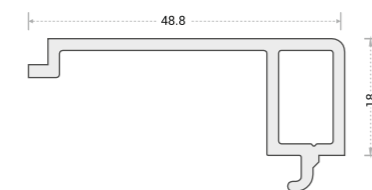

WEIGHT :- 0.279 Kg/M

PM-9002 : SLIDING SASH ADAPTOR

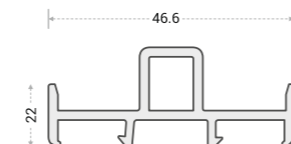

WEIGHT :- 0.355 Kg/M

PM-2303 : UNIVERSAL PROFILE

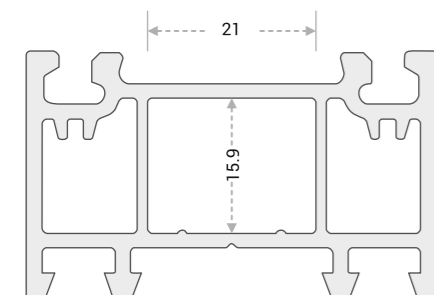

WEIGHT :- 0.560 Kg/M

Reinforcement

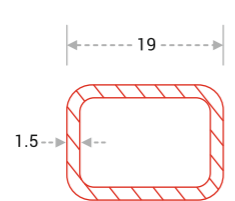

PM-9006 : 60*60 BAYPOLE

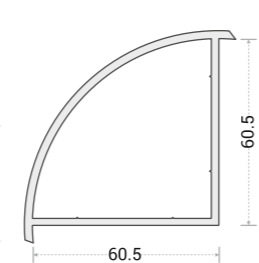

WEIGHT :- 0.761 Kg/M

Reinforcement

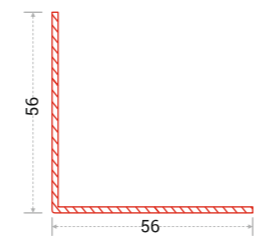

VILLA SERIES

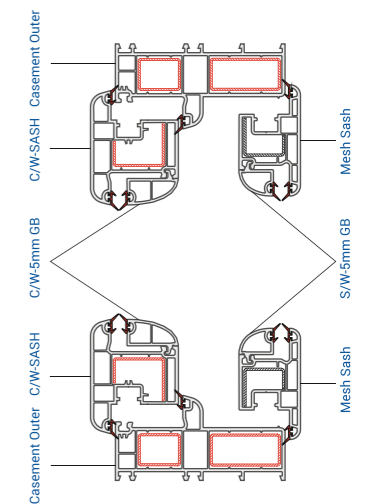
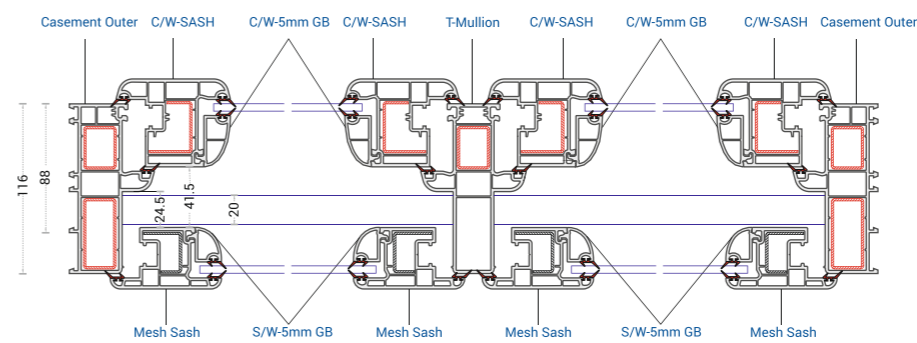
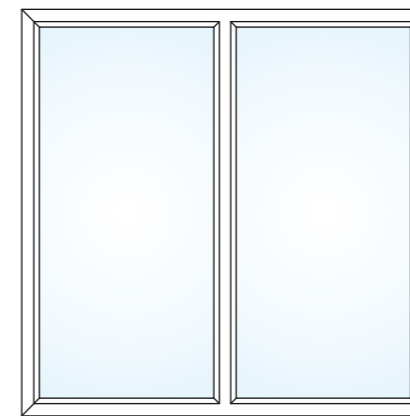

SLIDING 2 - TRACK SERIES

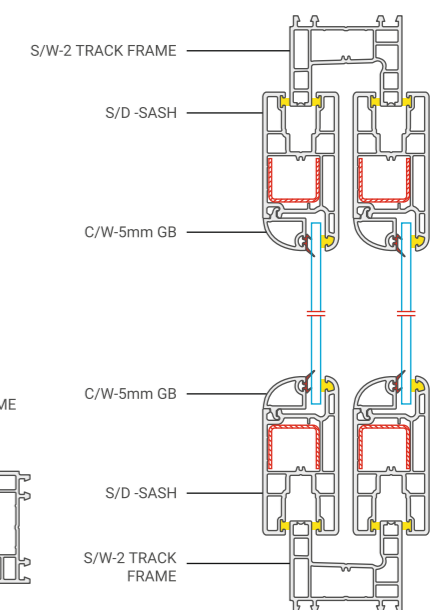
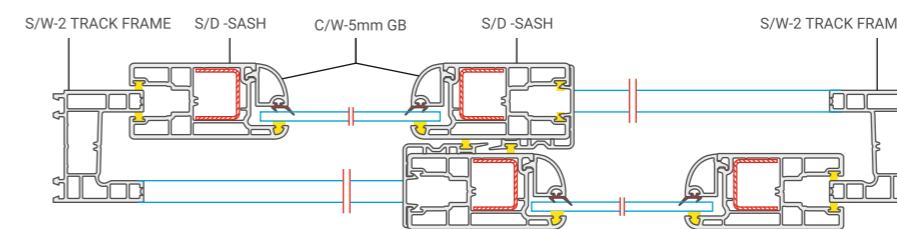
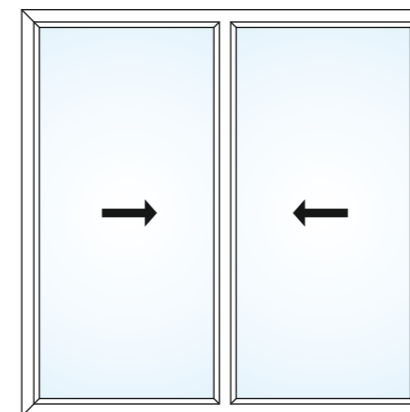

COLOUR uPVC WINDOWS

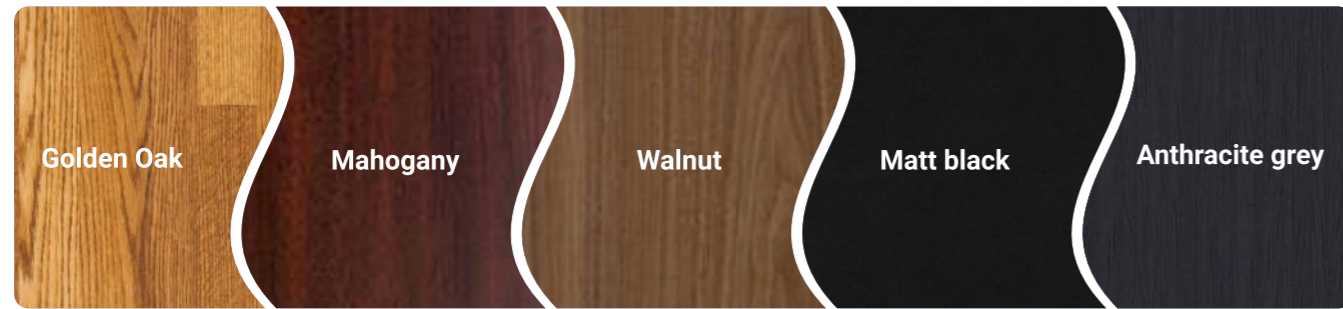

In the realm of modern architecture and design, windows have transcended their traditional roles, becoming artistic expressions in themselves. PROMAX Profiles are the canvas upon which your imagination can run wild.

As you select your window profiles, it's not just about classical white; it's a symphony of choices. It seamlessly merges with the modern architecture of your building, creating a harmony of colors that's nothing short of a visual masterpiece.



ATMY ANALYTICAL LABS PVT.LTD.

1-30, DLF Industrial Area, Phase-1, Faridabad (Haryana) INDIA
Phone: +91-129-4019544
info@atmylabs.com, www.atmylabs.com

- Testing
- Research
- Innovation

TEST REPORT

Report No.: 2303140034

Date: 20-03-2023

1. Mechanical Test		Test Performed on: 14-03-2023 to 20-03-2023	
Test Parameter	Unit	Result	Test Method
Vicat Softening Temperature	°C	84.8	ASTM D 1525
Flexural Modulus	MPa	2849.2	BS EN ISO 178
Charpy Impact	Kj/m2	60.6	ISO 179-2
Tensile Strength	MPa	52.01	DIN EN ISO 527
Elongation at Break	%	88.2	DIN EN ISO 527
Fire Resistance	-	Self-Extinguished	IS 4249

----- End of Report -----



Rahul

Rahul
ASSISTANT MANAGER-TESTING
Authorised Signatory



Authentication: To Check authenticity of Test report (s), Scan QR code to get original data

BIS, DGQA & Various Govt. Approved Laboratory
ISO 9001:2015, ISO 14001:2015 & OHSAS 18001:2007 Certified Laboratory

Terms & Conditions:

1. Sample will not be retained more than one month for chemical and three month for mechanical unless specified instructed.
2. Samples analysis conducted on as received basis and followed by customer description, unless specified otherwise.
3. The laboratory will not be liable for sample destroy/damage during testing, unless instructed otherwise.
4. Any Complaints matter about this report should be communicated in written, within 7 days of issue of this report.
5. The result listed refer only to the tested samples and applicable parameters as described by customer. Endorsement of product is neither inferred nor implies.
- 6 Total liability of our laboratory is limited to the invoiced amount only.
7. This report cannot be used as and evidence in a court of law without the written approval of the laboratory,

MSF 5.10.01

